



BROKEN ARROW

Where opportunity lives

DESIGN STANDARDS FINAL DRAFT STANDARDS

OCTOBER 6, 2017

DOWNTOWN RESIDENTIAL OVERLAY DISTRICT

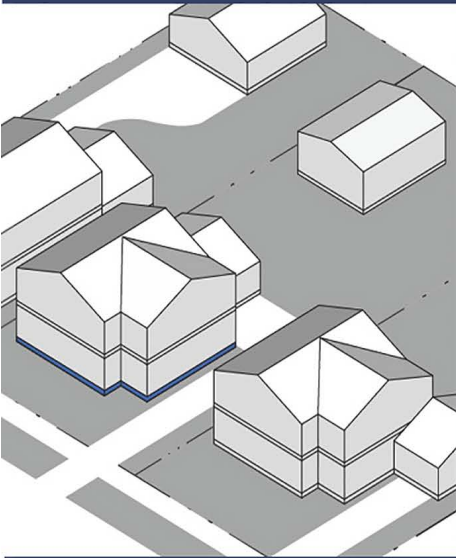

**CITY OF BROKEN ARROW
DOWNTOWN RESIDENTIAL OVERLAY DISTRICT (DROD)
DESIGN STANDARDS – FINAL DRAFT**

TABLE OF CONTENTS

I.	INTRODUCTION.....	1
II.	DOWNTOWN RESIDENTIAL OVERLAY DISTRICT (DROD) AREAS.....	2
III.	BUILDING FORMS.....	12
IV.	DESIGN INTENT STATEMENTS.....	18
V.	DESIGN STANDARDS BY BUILDING FORM.....	34
	A. SINGLE-FAMILY A.....	36
	B. SINGLE-FAMILY B.....	40
	C. TWO-FAMILY.....	44
	D. COTTAGE COURT.....	48
	E. 3-PLEX/4-PLEX/MANSION APARTMENT	52
	F. ROWHOUSE.....	56
	G. FLATS.....	60
	H. MIXED-USE A.....	64
	I. MIXED-USE B.....	68
VI.	REFERENCE SHEETS.....	73

Prepared by:



ADG
Oklahoma City, OK



Winter and Company
Boulder, CO

I. INTRODUCTION

PURPOSE OF THE DOWNTOWN RESIDENTIAL OVERLAY DISTRICT (DROD)

The Downtown Residential Overlay District (DROD) is intended to continue the implementation of the Downtown Master Plan by promoting compatible, high quality mixed-use and residential design in the area bounded by Elm Place, Houston Street, 9th Street (Lynn Lane), and Kenosha Street. For the purposes of this document, the DROD is sometimes referred to as “Downtown.” The DROD standards promote protection of sensitive established residential neighborhoods while also accommodating residential infill that contributes to an active and walkable area. The DROD is intended to facilitate residential and mixed-use conservation of residential character in stable neighborhoods, while also accommodating increased residential densities, mixed-use development and commercial activities in targeted areas to enhance activity and commerce. The DROD standards are intended to ensure that all new development and renovations promote the urban design principles established in the Downtown Master Plan, including:

Implement the Comprehensive Plan

The DROD Design Standards support the goals of the Broken Arrow Comprehensive Plan, particularly for areas designated as Downtown Area and Urban Residential. The Design Standards promote compatible residential infill development that exhibits good urban design principles, as called for in the Comprehensive Plan, as well as the Downtown Master Plan.

Promote High Quality Urban Design and Walkability

The DROD Design Standards promote development that enhances the public realm in Downtown, including streets, alleys, sidewalks and other public spaces. The Design Standards are intended to facilitate residential and mixed-use development that is visually interesting, pedestrian-friendly and of a quality that benefits the Downtown experience and its design character. Thus, new development should employ design features to break up large masses and avoid monotonous walls in order to increase comfort for the pedestrian and the overall appearance of Downtown.

Respond to Context and Key Features

The DROD Design Standards are tailored to respond to existing development patterns and neighborhoods in different parts of Downtown. The Design Standards are customized to respond to the degree of change that is appropriate in a given area or in some cases a desire to maintain the current character.

Respect Established Development Patterns

The DROD Design Standards respond to the design traditions throughout each individual neighborhood within the DROD. Development patterns, including lot size and depth, typical building widths, and the presence of architectural features, are all important in determining a neighborhood’s design traditions and physical characteristics. Creative and contemporary designs, as well as increases in density, are promoted in certain areas, provided design features are included to promote compatibility.

II. DOWNTOWN RESIDENTIAL OVERLAY DISTRICT (DROD) AREAS

The Downtown Residential Overlay District (DROD) is divided into seven (7) distinct Areas, each of which has unique objectives for new development and substantial renovations to existing properties. The Area boundaries are based on several factors, including:

- The periods in which development historically occurred
- Original subdivision boundaries
- Existing building forms and scale
- Existing architectural characteristics
- Comprehensive Plan objectives
- Downtown Plan objectives
- Community input

The Area boundaries also consider the degree to which an area's character should be maintained or transformed as redevelopment occurs. An intent statement is provided below for each Area. Each intent statement broadly describes the desired future character for the Area. The map in Figure 2.1 identifies the DROD Area boundaries.

Broken Arrow Downtown Residential Overlay District (DROD) Areas

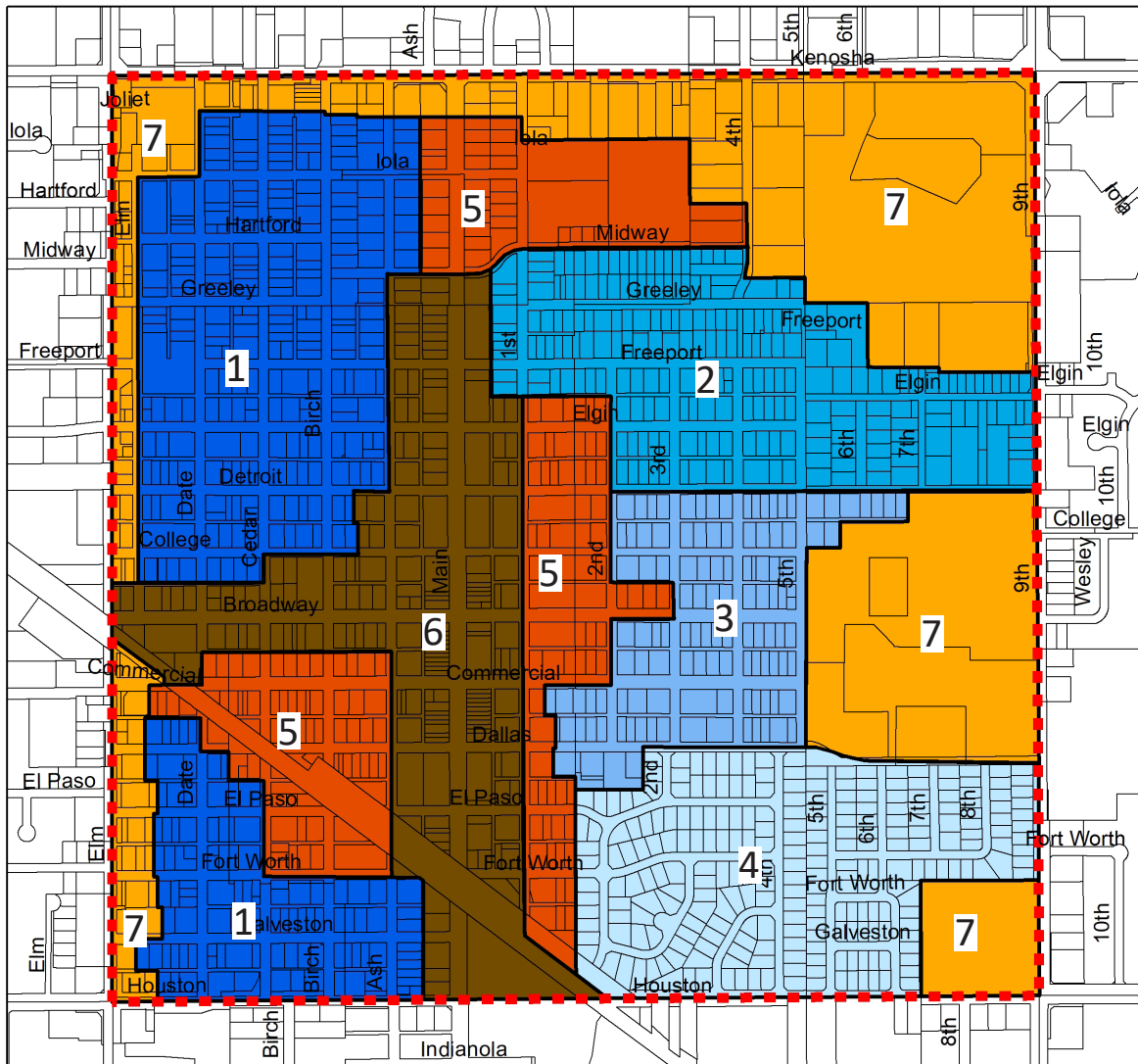



Legend

DROD Overall Boundary

 DROD Overall Boundary

DROD Areas

 Area 1: Residential 1

 Area 2: Residential 2

 Area 3: Residential 3

 Area 4: Residential 4

 Area 5: Rose District Transition

 Area 6: Commercial/Mixed Use Core

 Area 7: Commercial/Mixed Use Corridor

DROD Area 1: Residential 1

DROD Area 1 includes two discontinuous areas within the interior of the DROD, west of Main Street, east of Elm Place, north of Houston Street and south of Kenosha Street. Area 1 was originally developed as traditional single-family neighborhoods, but over time have been transformed into residential districts that exhibit a wide variety of building forms, including single-family homes, two-family properties and varying types of multi-family buildings.

Area 1 should accommodate variety in architecture and building form, but maintain a residential character. New construction and renovations should reflect some of the characteristics of traditional single-family homes, by limiting the width and scale of new buildings. However, to accommodate a variety of building forms and encourage architectural variety, flexibility should be provided to promote an eclectic neighborhood that accommodates a variety of Downtown living options. Design creativity should be encouraged, but employed in a fashion that ensures compatibility of non-single family forms with the primarily single-family residential context.

Over time, Area 1 should become more urban in nature, exhibiting a frequent rhythm of building entries, small front setbacks and front building wall widths. Development should contribute to an engaging streetscape that promotes walkability by orienting buildings toward the street, minimizing the visibility of garages, and minimizing vehicular-pedestrian conflicts. New development should also incorporate re-use of alleyways, where they are available.

Building forms in Area 1 will range from conventional single family homes on smaller, single lots to moderately scaled multi-family flats on adequately sized lots.

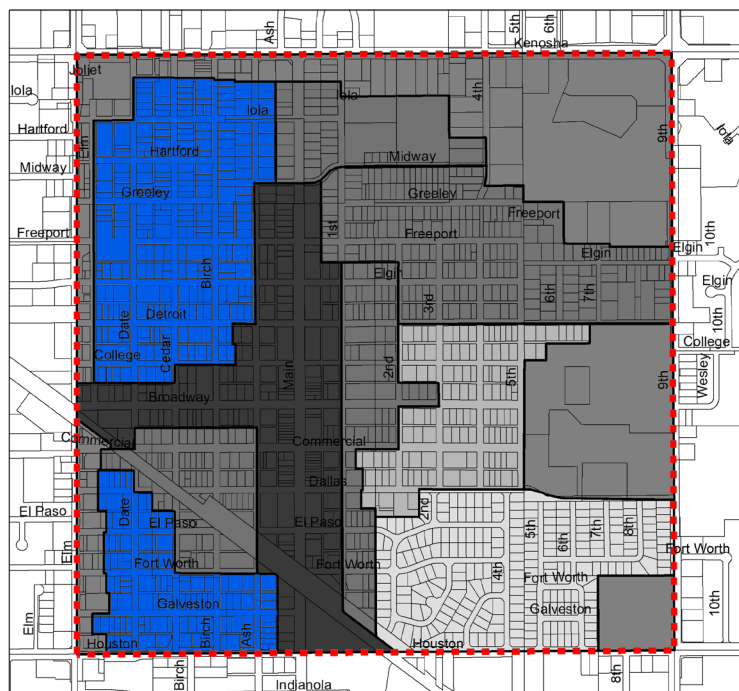

Figure 2.2

DROD Area 2: Residential 2

DROD Area 2 includes one contiguous area within the interior of the DROD, generally located east of Main Street, west of 9th Street (Lynn Lane), north of Detroit Street and south of Midway Avenue. Area 2 was originally developed in the 1940's as a single-family residential neighborhood and has generally retained this character over time. Area 2 currently contains single-family homes and a small number of two-family homes. While building forms are generally consistent throughout this Area, architectural character (like materials and individual elements) and scale vary significantly from block to block and house to house.

Development in Area 2 should continue to reinforce the established single-family residential character while facilitating moderate increases in density through the accommodation of Accessory Dwelling Units (ADU) and Two-family units.

Designs should express variety in architectural character while maintaining a generally consistent single-family form. For example, variety in materials should be promoted while the scale and width of buildings should be sized to be compatible with existing buildings.

Development in this area should contribute to an engaging streetscape that promotes walkability by orienting toward the street, minimizing the visibility of garages and minimizing vehicular-pedestrian conflicts. New development should also incorporate re-use of alleyways, where they are available.

Building forms in Area 2 may range from conventional single-family homes on a single lot to two-family attached units, while also accommodating Accessory Dwelling Units (ADUs).

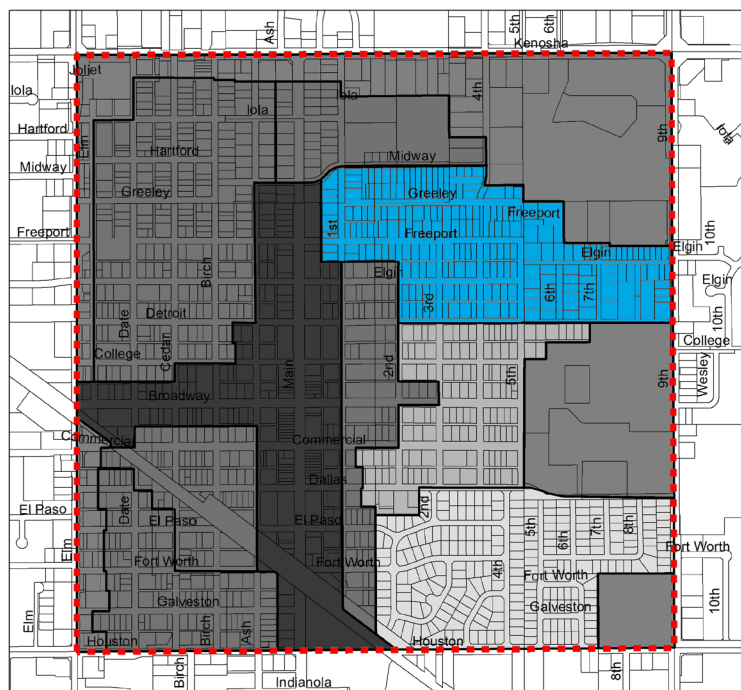

Figure 2.3

DROD Area 3: Residential 3

DROD Area 3 consists of a contiguous area in the interior of the DROD, located east of Main Street, West of 9th Street (Lynn Lane), South of Detroit Street and generally north of Dallas Street. Area 3 is unique in that it contains the most consistent collection of traditional single-family forms and architectural character within the DROD. While some infill and alterations have occurred and periods of development vary, architectural character and form is relatively consistent within individual blocks.

Area 3 should retain its single-family residential character by promoting moderately scaled building forms and compatible architectural character. New infill development and renovations should be designed to be expressly compatible with the single-family traditional context and the block in which they are located.

Development should include design elements and features, such as porches, pitched roofs, and subordinate garages, which fit in with the traditional context. Building features, including the overall height of a building (or specific portions of a building), should be scaled to maximize compatibility.

Development should contribute to an engaging streetscape that promotes walkability by orienting toward the street, minimizing the visibility of garages and minimizing vehicular-pedestrian conflicts. New development should also incorporate re-use of alleyways, where they are available.

Building forms in Area 3 should be generally limited to single family, but appropriately scaled and compatible accessory dwelling units should also be accommodated.

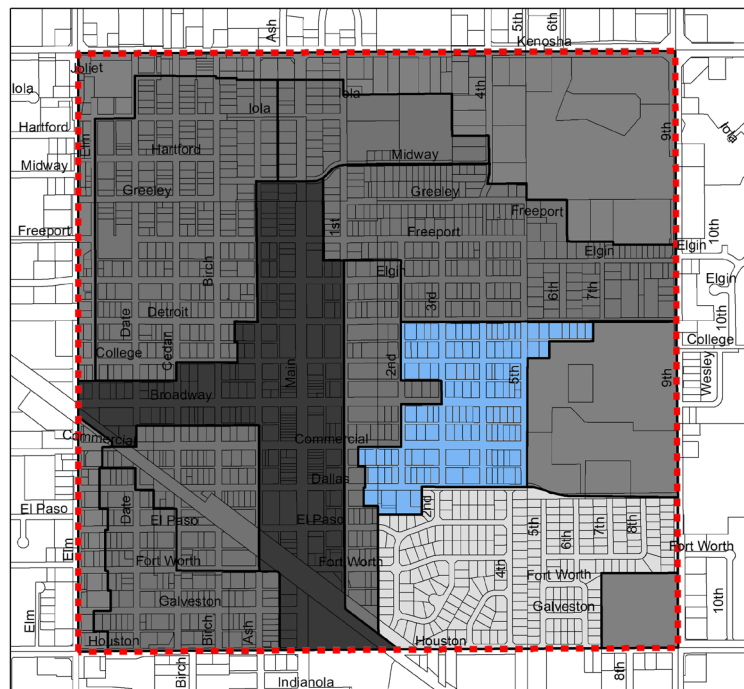

Figure 2.4

DROD Area 4: Residential 4

DROD Area 4 is a contiguous area in the southeastern portion of the DROD. It is located east of Main Street, north of Houston Street, south of Dallas Street and generally west of 9th Street (Lynn Lane). Area 4 contains single-family neighborhoods developed in the 1950's and 1960's. Block pattern, parcel shape and orientation, and building designs are uniquely different from the more uniform, gridded single-family neighborhoods in the majority of the DROD. This area contains the most consistent collection of mid-century single-family forms and architectural character within the DROD. Building form is quite similar from property to property. With some exceptions, homes are one-story with prominent front-loaded garages and small entry stoops or porches. Low pitched roofs differentiate these houses from steeper pitched roof forms seen in other residential neighborhoods in the DROD. The wider dimensioned wall is typically placed parallel to the street, making the single-family residential homes in this area horizontally-oriented with elongated, asymmetrical facades.

Area 4 should be maintained as a single-family residential neighborhood with a high degree of design consistency. This should be achieved by exclusively promoting single-family building forms. New construction and significant renovations should be designed to be compatible in form and scale to the existing context, particularly for parts of the building that are closest to the street. Building features, including the overall height of a building (or key portions of a building), should be scaled to be compatible with the mid-century context.

Development should be designed to contribute to an engaging streetscape that promotes walkability by orienting toward the street, minimizing the presence of blank walls adjacent to the street and minimizing the visual impact of garage doors.

Building forms in Area 4 should be limited to single family, but appropriately scaled and compatible accessory dwelling units also should be accommodated.

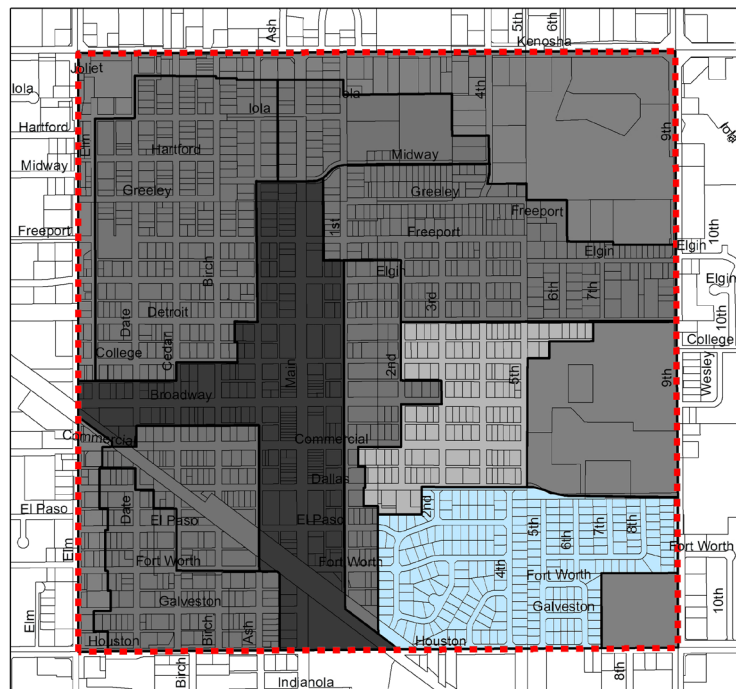

Figure 2.5

DROD Area 5: Rose District Transition

DROD Area 5 occurs in several locations between the DROD's perimeter corridors and interior residential areas. It also serves as a transition between the Rose District to residentially focused Areas. Area 5 currently exhibits a wide variety of architectural character, forms and even land uses. Significant infill and change has occurred in many of portions of Area 5, creating no consistent pattern of development.

Building off of the policies in the Downtown Master Plan, Area 5 should transform significantly over time by accommodating more intensive residential and commercial development that supports Downtown business and extends the active, urban character of the Rose District. However, the area must also serve as a transition that buffers intensive commercial/mixed-use development from interior residential areas. As such, new construction and significant renovations should include a variety of building forms ranging from single-family to rowhouses to mixed-use buildings with limited commercial, such as neighborhood-level retail or small offices.

Variety in architectural character and building form should be encouraged to create an eclectic mix of housing and non-residential activities that directly supports the Rose District. Architectural creativity, contemporary design and modern building forms should mix with traditional ones to support this objective. Variety in building materials, roof forms and other features is encouraged in Area 5.

Development in Area 5 should contribute to an engaging streetscape and support a highly walkable environment, particularly in the areas closest to the Rose District. Buildings should be designed to orient strongly to the street, creating a consistent street edge with buildings placed relatively close to the street.

Ground floor transparency and interaction between private properties and the public street should be maximized with both residential and commercial uses through the use of windows, doors, porches, stoops, storefronts, significant glazing and other features.

Building forms in Area 5 will range widely within the district and a mix of forms within a single block is appropriate and encouraged. Forms will include rowhomes, moderately scaled flats and mixed-use buildings with limited retail uses.

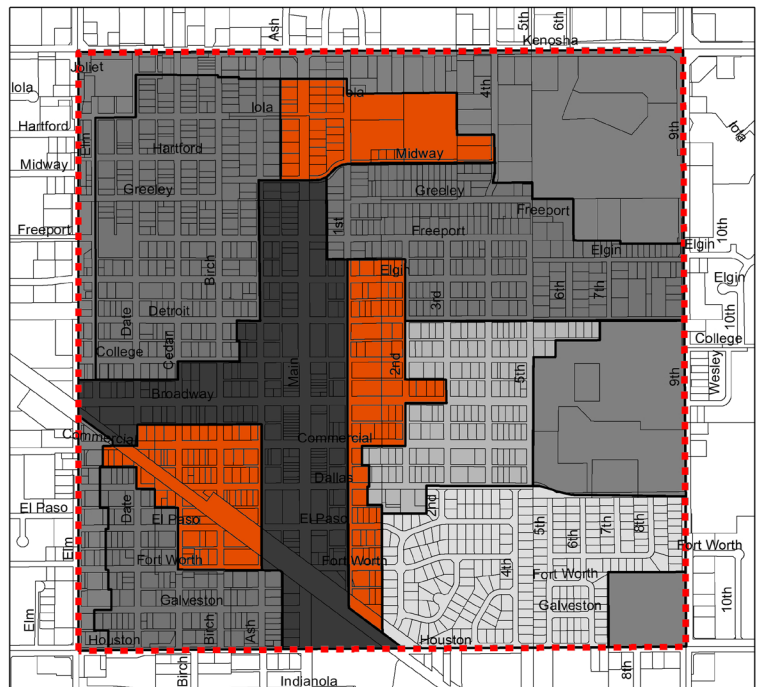

Figure 2.6

DROD Area 6: Commercial/Mixed-Use Core

DROD Area 6 consists of the core Rose District properties that surround Main Street and West Broadway Avenue. These areas exhibit a wide variety of building forms, architectural characteristics and land uses. Buildings in this area strongly orient to Main Street and West Broadway. Broken Arrow's traditional commercial district is generally located in this area along Main Street, between College and El Paso Streets. Other segments of Main to the north and south of this core, as well as West Broadway, exhibit a mix of residential and commercial development that continues to redevelop and change.

As described by the Broken Arrow Downtown Master Plan, the core of the DROD along Main Street exhibits a variety of architectural styles, which should continue in future development. New construction should be built to create a consistent street wall by promoting buildings to be built to the back of the sidewalk and at heights of two stories or greater. These same principles and design standards should be promoted along West Broadway and along the full span of Main Street through the DROD. New construction in Area 6 will include a variety of building forms to increase intensity, activity and a pedestrian-oriented, urban feel; including rowhouses, flats, mixed-use and commercial building forms.

Variety in architectural character and building form will continue to be promoted to create an eclectic mix of commercial and high-density residential development.

New construction in Area 6 should establish active pedestrian street edges by incorporating active uses along the ground floor and by providing high degrees of transparent storefronts. The incorporation of awnings and architectural details along the ground floor and upper stories will also enhance the pedestrian street edges. The interaction between private properties and the public street should be maximized to the fullest extent feasible through the use of windows, doors, porches, stoops, storefronts and other features.

Building forms in Area 6 will include residential rowhouses and larger flats and mixed-use commercial. A mix of these forms at multiple stories is appropriate and encouraged.

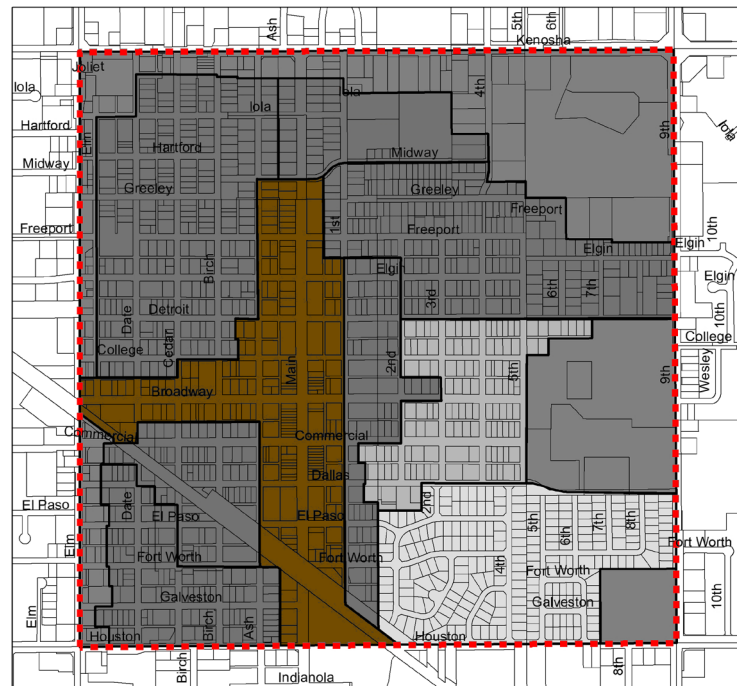

Figure 2.7

DROD Area 7: Commercial/Mixed-Use Corridor

DROD Area 7 includes properties at the perimeter of the DROD, including along Kenosha Street, Elm Place, 9th Street (Lynn Lane) and Houston Street. This Area currently contains a wide variety of land uses and building forms, including single-story auto-oriented strip retail, land intensive commercial uses (like auto-mechanics and auto dealers), industrial buildings, institutional buildings and vacant land. Buildings are typically set back significantly from the streets they face to accommodate surface parking lots near the roadway. No discernible patterns of architectural character appear in the area.

Scale of development is relatively low today, but Area 7 represents one of the best opportunities to develop higher intensity commercial, mixed-use and residential building forms that will support and complement the Rose District.

Area 7 should accommodate redevelopment with high-quality and well-designed commercial, mixed-use and multi-family buildings. While it is likely to continue to be auto-oriented in nature, properties should be designed with quality materials and landscaping and be designed to enhance walkability. Buildings should be placed to create a relatively consistent street edge along the perimeter corridors by minimizing the amount of surface parking provided between buildings and the street. Buildings in this Area should be designed to transition sensitively to adjacent areas of residential character. Clearly defined entries, variation in materials, and articulation of larger building masses should all contribute to improved design in Area 7.

Building forms in Area 7 will focus on building forms that accommodate higher density and land use intensity, including larger residential flats, mixed-use and commercial building forms. A variety of building heights, both within individual projects and along the block, is appropriate and encouraged.

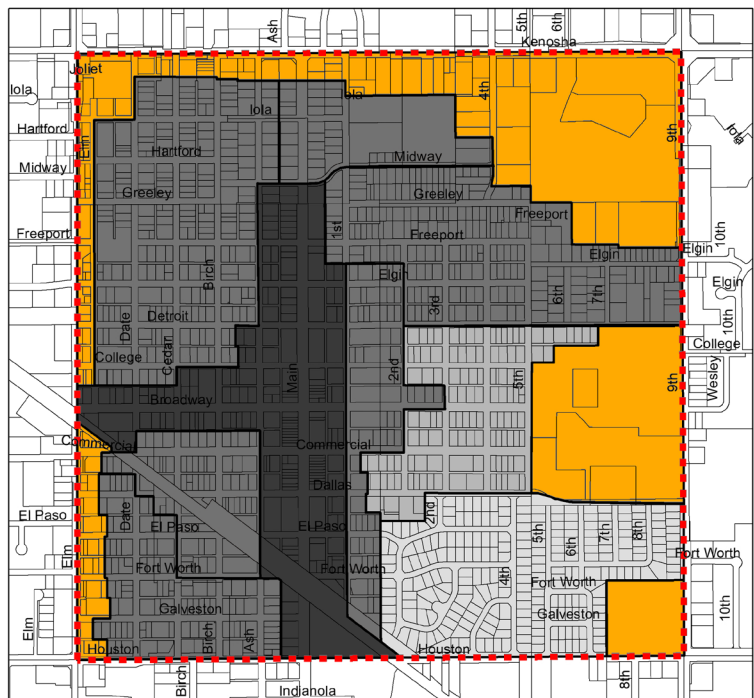

Figure 2.8

III. BUILDING FORMS

PURPOSE OF THE DOWNTOWN RESIDENTIAL OVERLAY DISTRICT (DROD)

The nine building forms permitted on properties in the Downtown Residential Overlay District (DROD) appear as the column headers in Table 1 below. The building forms are intended to accommodate a variety of residential and commercial uses at varying intensities that fit appropriately within the different Areas of Downtown, which appear as the row titles in Table 1.

These building forms will promote activity, business and a pedestrian-friendly environment. Each building form is described through the remainder of this chapter in terms of physical characteristics and the land uses that each respectively accommodates. Building and site design standards for each of the building forms and as further refined by Area are provided in Chapter 5.

		Single-Family A (Traditional)	Single-Family B (Mid Century)	Two-Family	Cottage Court	3-Plex/4-Plex/Mansion Apartment	Rowhouse	Flats	Mixed-Use A (Neighborhood)	Mixed-Use B / Commercial	Accessory Dwelling Unit (ADU) ¹
DROD Area	Area 1 Residential 1	P	P	P	P	P	P	P			P
	Area 2 Residential 2	P	P	P							P
	Area 3 Residential 3	P	P								P
	Area 4 Residential 4		P								P
	Area 5 Rose District Transition	P	P			P	P	P	P		
	Area 6 Commercial/ Mixed-Use Core						P	P		P	
	Area 7 Commercial/ Mixed-Use Corridor							P		P	

Table 1: Permitted Building Forms

P = Permitted C = Conditional

Projects not permitted by right (P), may be considered through the Planned Unit Development (PUD) process.

1 Accessory Dwelling Units do not have specialized design standards unless otherwise noted. They are subject to the design standards in the areas in which they are permitted

PLANNED UNIT DEVELOPMENT (PUD)

Projects not permitted by right (P) may be considered through the Planned Unit Development process (PUD). The PUD is established as an overlay zoning district and is intended as an alternative to conventional development. Approval of a PUD requires the submission to the Planning Commission and the City Council of a proposed outline development plan and accompanying development standards applicable to a particular tract, for discretionary review (See Section 6.4).

SINGLE-FAMILY A

The “Single-Family A” building form is a detached house that is a small-scale, freestanding building, typically 1 to 2.5 stories in height. This form occurs as a single building on a lot and it may include building details such as a front porch, front stoop and attached or detached garage. This type of single-family home is typically set back from the public right of way and adjacent lots, and is slightly elevated above the ground. It typically includes a moderately pitched roof form and is designed with the smaller dimension of the building footprint parallel to the street. In some cases, a flat roof shape is employed. This building form is ideally designed to facilitate residential uses.



Figure 3.1 (top) and Figure 3.2 (bottom) illustrate two styles of the Single-Family A building form.

SINGLE-FAMILY B

The “Single-Family B” building form is a detached house that is typically one-story in height. This form occurs as a single building on a lot. This free-standing building is typically set back from the public right of way and adjacent lots, and is slightly elevated above the ground. A small porch or stoop brings attention to the primary entrance to the single-family building. The single- or double-car garage is generally attached to the primary structure, most often placed flush with the front-most wall of the building. It typically includes a low-pitched roof form and is horizontally aligned to the street. This building form is ideally designed to facilitate residential uses.



Figure 3.3 illustrates the Single-Family B building form is one-story in height and is horizontally aligned to the street.

TWO-FAMILY

The “Two-Family” building form exhibits a similar shape and architectural features to the “Single-Family A” building form, but allows for a slightly higher density. The Two-Family building form can be designed as two side-by-side single-family units; can be a form split with one unit facing the primary street and the other facing a secondary street, backyard, or side yard; and can be a form with one unit on the ground-level and the other on the upper-level. Parking is provided for each of the units. Parking can take the form of a shared, attached garage; a shared, detached garage; individual, attached garages; or individual, shared garages.

COTTAGE COURT

This building form consists of a series of small, detached structures, providing multiple units arranged around a common courtyard, which is oriented perpendicular to the street. The common courtyard provides usable, shared open space in lieu of a private rear yard and becomes an important community element. This building form is sized to fit within single-family and medium density neighborhoods. The Cottage Court building form enables appropriately scaled, well-designed higher densities and is important for providing a broad choice of housing types and promoting walkability. Parking in Cottage Court developments can occur in many fashions: as attached or detached garages tied to individual homes, as attached carports, within detached communal garages, or within scattered surface parking lots.



Figure 3.4 (top) and Figure 3.5 (bottom) illustrate a side-by-side Two-Family building form exhibits similar building features to Single Family A.

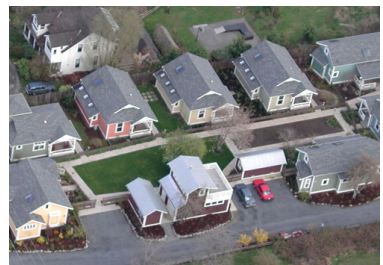

Figure 3.8 (top) and Figure 3.9 (bottom) illustrate the Cottage Court building form that is defined by a common courtyard. The entries for all interior units face the common courtyard, while the end units face the common courtyard or the adjacent street.

3-PLEX/4-PLEX/MANSION APARTMENT

A 3-plex/4-Plex/Mansion Apartment building form provides an opportunity for increased density in a single-family context. While providing multiple units within one building, this building form appears to be similar in size and shape to that of a large single family house, utilizing a single roof, shared entry or entries and shared outdoor space. While this building form may be larger than neighboring single-family buildings, its setbacks, parking location and wall articulation features make it an appropriate building form that allows for increased density in the single-family context.

ROWHOUSE

This building form consists of a series of attached units that are narrow and tall, with entries facing the street (on street adjacent walls). This building form has a limit to the width of the total building length so that it relates to neighboring structures and provides a defined front wall for each unit. The Rowhouse form is often raised moderately off the ground and accessed by a porch or stoop to draw attention to the individual entry for each unit. A variety of articulation methods can be used to distinguish each rowhouse unit, including changes in material, wall offsets, and changes in color. Detached garages or a “tuck under garage” (provided within the first floor of each unit) accessed by an alley or internal access drive is typical.



Figure 3.6 (top) and Figure 3.7 (bottom) illustrate two interpretations of the 3-Plex/4-Plex/Mansion Apartment appear as a large, single-family residence, while providing multiple units.



Figure 3.10 (top) and Figure 3.11 (bottom) illustrate the Rowhouse building form that shows street-facing entries and distinguishes between each rowhouse unit through the use of wall offsets and changes in material.

FLATS

A Flat is a multi-story, residential building form that increases density in targeted single-family areas and provides an additional housing option in commercial and mixed-use areas. A flat includes floors of “stacked” residential units. Common entries and circulation corridors typically provide access to individual units. Flats may be single-loaded with a circulation hallway on one side of the building or double-loaded with units on both side of a building with a common hallway through the middle. The location and connection of an entry to the street and the articulation of the building walls provide architectural interest and create a more pedestrian-friendly environment. Parking in Flats-style developments typically occurs in shared surface parking lots, but can also occur in structured garages, as market forces allow.

MIXED-USE A

This building form facilitates office and residential uses within one structure mixed vertically and/or horizontally, with limited supporting retail. Its scale and intensity is limited to facilitate a neighborhood-compatible mixed-use building that transitions appropriately to areas of strictly residential character. For instance, these may take the form of a small corner shop with rowhouses or flats continuing down the block. The ground-floor requires transparency minimums for certain retail uses as well as limits on the linear percentage of active storefronts. Mixed-use A also accommodates offices and residential uses. This very flexible building form may include components of many other building forms described in this Chapter. Parking for residents and office and retail employees in this building form is typically aggregated in adjacent surface parking lots or structured garages. However, buildings that are predominantly residential may also incorporate individual garages within the design of the primary structure. This building form also commonly requires nearby, on-street parking for short-term office visitors and retail patrons.



Figure 3.12 (top) and Figure 3.13 (bottom) Illustrates the Flats building form which increases density in single-family areas and provides an additional housing option in commercial and mixed-use areas.



Figure 3.14 (top) Illustrates the Mixed-Use A buildings type which exhibits small corner shops with rowhouse and flats on the remainder of the block.

MIXED-USE B/COMMERCIAL

This form facilitates the mixing of commercial, office and potentially residential uses within one structure. Mixed-Use B/Commercial also accommodates commercial or office uses as sole uses within a single building. It is characterized by generous ground floor heights, active ground floor uses (such as shops or offices). In many cases, office or residential components are included on upper floors with the ground floor dedicated to retail uses. Entries are typically clearly demarcated for individual components of a building, like common residential entries or storefronts. Ground floors are highly articulated and exhibit high percentages of transparency. Internal circulation is critical to connecting uses within the building and elevators are widely used where multiple stories exist. Parking for residents and office and retail employees in this building form is typically aggregated in adjacent surface parking lots or structured garages. This building form exhibits a high number of visitors and shopping patrons, which makes high-turnover, on-street parking critical.



Figure 3.15 (top) and Figure 3.16 (bottom) illustrates the Mixed-Use B/Commercial building form that can be designed and articulated in many ways to accommodate a variety of uses.

IV. DESIGN INTENT STATEMENTS

LOT

Standards in the “Lot” category are intended to ensure that a site is adequately sized and dimensioned to accommodate a particular building form, consistent with the intent of the DROD Area in which it is located. Lot dimension requirements help ensure that a consistent and compatible horizontal rhythm of buildings is established along a public street and that a project with multiple units or buildings on one lot does not appear overly dense in relation to residential properties nearby. Lot requirements are particularly important in areas where single-family homes are prominent.

Where a site will be subdivided into more than one parcel (a potential situation for Rowhouse, Cottage Court, Two-Family and 3-Plex/4-Plex/Mansion Apartment), lot design standards should be based on the collective area of all parcels. Figures 4.1 and 4.2 illustrate a project site that remains 1 parcel, despite the individual rowhouse units. Figures 4.3 and 4.4 illustrate a project site that was subdivided into individual parcels based on units. While this project is subdivided, the lot design standards should still be based on the collective area of all parcels.

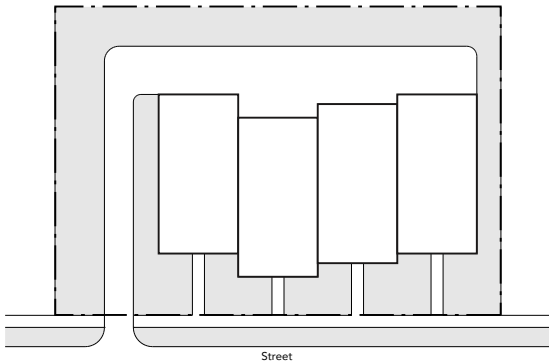

Figure 4.1

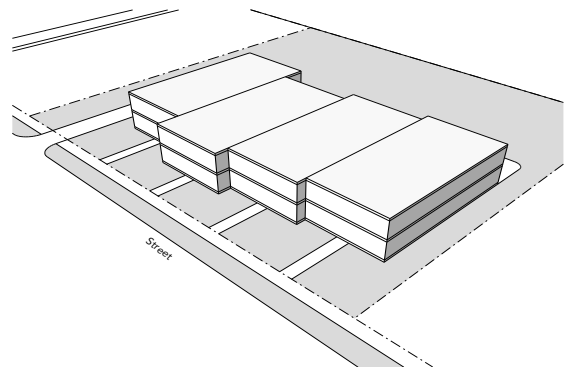

Figure 4.2

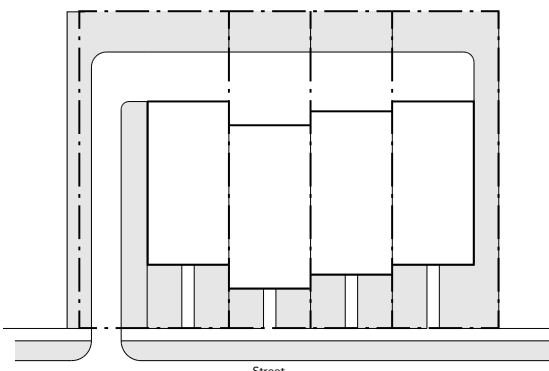

Figure 4.3

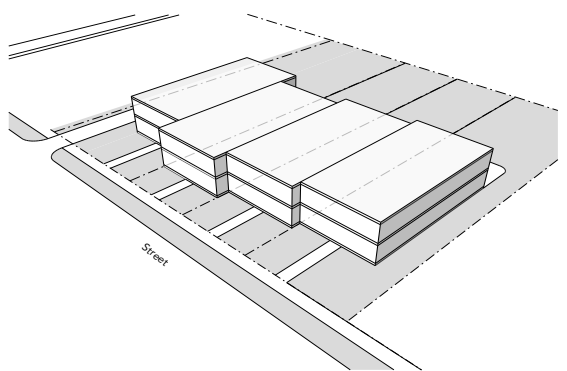

Figure 4.4

Lot Area:

This standard seeks to establish a minimum lot size that is compatible with properties in a given DROD Area. Minimum lot sizes are provided for each building type. This standard is intended to reflect traditional lot sizes and widths in each individual Area and seeks to provide adequate site area to accommodate particular building types.

Lot Area applies to: Single-Family A, Single-Family B, Two-Family, 3-Plex/4-plex/Mansion Apartment, Cottage Court, Rowhouse, Flats, Mixed-Use A

Lot Frontage:

This design standard establishes a minimum linear width for an individual lot that is parallel to the street. It is intended to accommodate the permitted building type(s) in that Area and establish a consistent horizontal rhythm of buildings along a block and within a specific Area.

Lot Frontage applies to: Single-Family A, Single-Family B, Two-Family, 3-Plex/4-plex/Mansion Apartment, Cottage Court, Rowhouse, Flats, Mixed-Use A

Lot Depth:

This design standard establishes a minimum linear distance from the front lot line to rear lot line in order to accommodate the Cottage Court building form, which allows multiple detached structures on a single lot. This design standard aims to ensure adequate depth to accommodate two or more structures between the front and rear lot lines, and to accommodate the common courtyard space of a Cottage Court building form, as well as parking for each unit and driveway access.

Lot Depth applies to: Cottage Court

Lot Coverage:

This design standard is intended to limit the ratio of built areas to landscaped areas on a lot by designating a maximum percentage of lot that can be covered by structures or impervious surfaces, such as surface parking and driveways. Lot coverage ensures that a minimum amount of undeveloped or open space is retained on a parcel to encourage retaining yard area proportions consistent with other properties in an Area, and particularly those of a residential character.

Lot Coverage applies to: Single-Family A, Single-Family B, Two-Family, 3-Plex/4-plex/Mansion Apartment, Cottage Court, Rowhouse, Flats, Mixed-Use A

SITE

Standards in the “Site Design” category are intended to ensure that the arrangement and relationship between various elements on a site have a positive impact on the property and the surrounding neighborhood. Site standards identify where buildings, parking and other elements should be located on a site to promote a visually cohesive neighborhood, establish a rhythm of buildings along a street, minimize the visual impact of parking and garages on the neighborhood and ensure that sufficient light, air and privacy are preserved between adjoining properties. They also promote efficient and safe circulation of pedestrians and vehicles, as well as a minimization of pedestrian/vehicle conflicts.

Where a site will be subdivided into more than one parcel (a potential situation for Rowhouse, Cottage Court, Two-Family and 3-Plex/4-Plex/Mansion Apartment), site design standards should be based on the collective area of all parcels. Figures 4.5 and 4.6 illustrate a project site that remains 1 parcel, despite the individual rowhouse units. Figures 4.7 and 4.8 illustrate a project site that was subdivided into individual parcels based on units. While this project is subdivided, the site design standards should still be based on the collective area of all parcels.

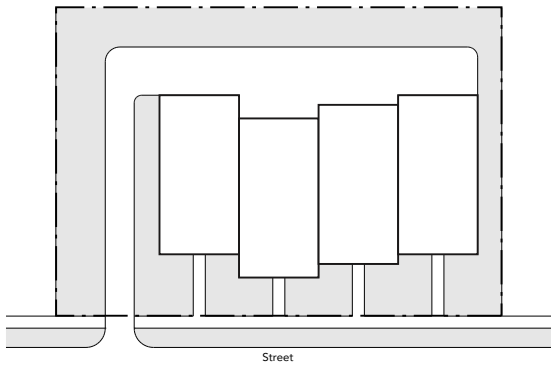

Figure 4.5

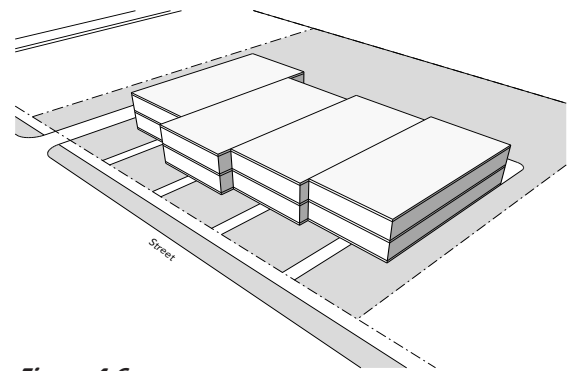

Figure 4.6

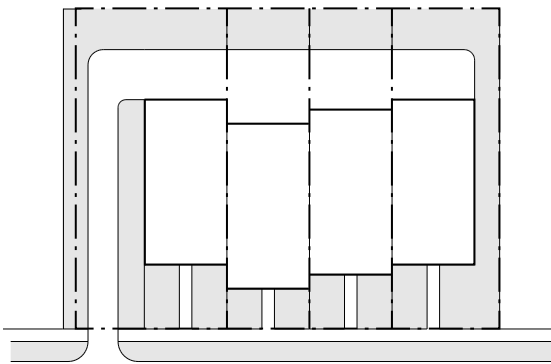

Figure 4.7

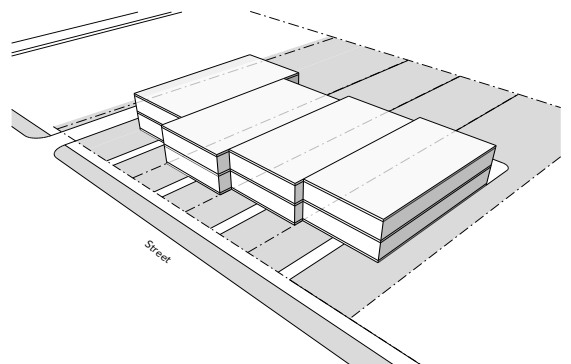

Figure 4.8

Front Setback/Build to Zone:

This standard is intended to establish a consistent placement of buildings along a block such that the buildings frame the street space. Placement of buildings closer to the street strengthens the visual connection between the street and buildings. This creates visual interest along a block, which enhances walkability. The front setback is measured from the front property line to the front wall. The Build to Zone (BTZ) is measured from the required front setback to the distance specified in the design standards tables (in Chapter 5). A percentage of the front wall is required to be built in the BTZ. The percentage varies by building form and Area. See Figure 4.9 for an example.

Front Setback/Build to Zone applies to: Single-Family A, Single-Family B, Two-Family, 3-Plex/4-plex/Mansion Apartment, Cottage Court, Rowhouse, Flats, Mixed-Use A, Mixed-Use B/Commercial

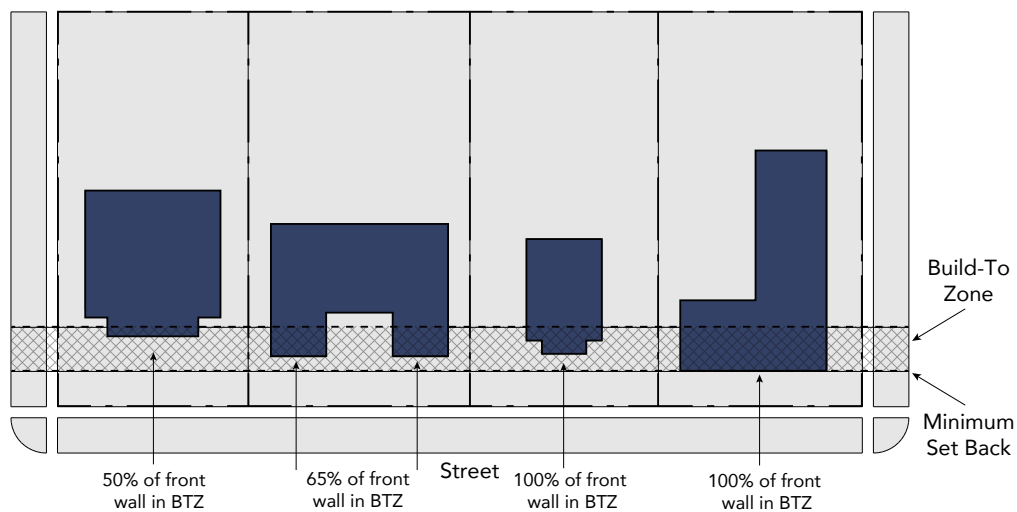

Figure 4.9

Side Setback:

This design standard is intended to establish horizontal spacing of buildings to create a rhythm along the street and to ensure adequate spacing between buildings. Side setbacks are intended to provide for privacy between properties and adequate light and air access.

Side Setback applies to: Single-Family A, Single-Family B, Two-Family, 3-Plex/4-Plex/Mansion Apartment, Cottage Court, Rowhouse, Flats, Mixed-Use A, Mixed-Use B/Commercial

Rear Setback:

This design standard is intended to ensure adequate privacy between properties that abut one another at the rear of a lot. It is also intended to provide for adequate light and air access to adjacent properties.

Rear Setback applies to: Single-Family A, Single-Family B, Two-Family, 3-Plex/4-Plex/Mansion Apartment, Cottage Court, Rowhouse, Flats, Mixed-Use A, Mixed-Use B/Commercial

Transitional Setback:

This standard is intended to establish a sympathetic interface between neighboring structures. It helps to ensure light and air access and privacy for properties located adjacent to new buildings that are greater than one story in height. Figure 4.10 below illustrates a transitional setback at a shared lot line. The numbers utilized display specifications that may apply to some building forms; consult design standards for the specific building type proposed to verify the standards.

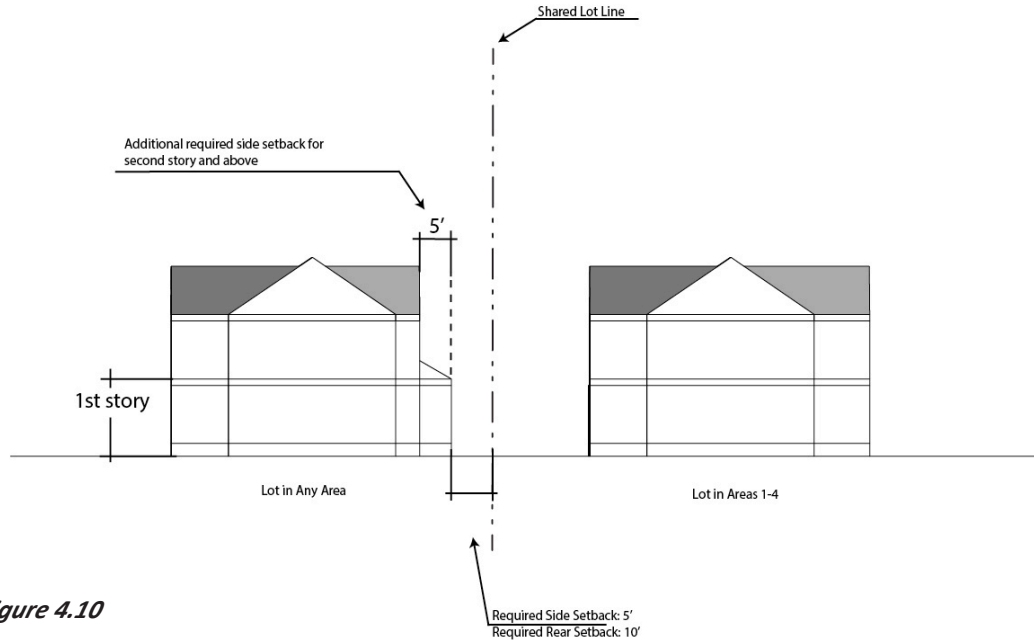

Figure 4.10

Upper Floor Street Setback:

This standard is intended to foster new development that is compatible with existing traditional downtown commercial buildings by maintaining a 3-story scale at the street wall. By requiring an increased setback above the 3rd floor, the scale is maintained and it also ensures that light and air access is provided for the street. Figure 4.11 illustrates that an increased upper floor setback of a minimum of 15' from the front property line is required above the 3rd story. A recommended setback distance from the front wall is also provided.

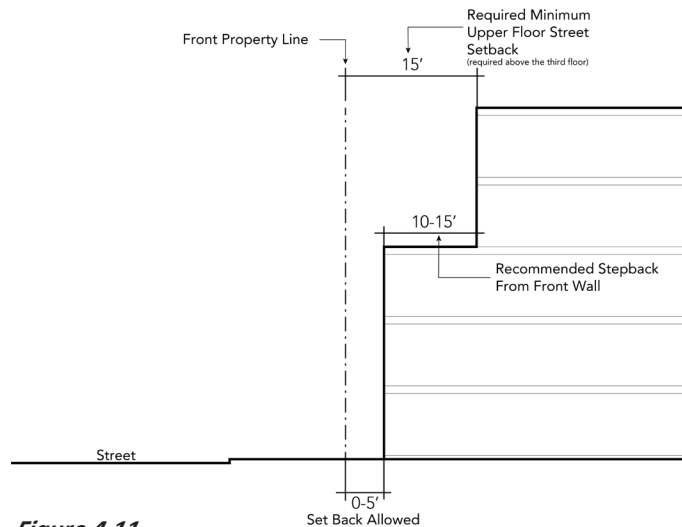

Figure 4.11

Space Between Buildings:

This standard is intended to prevent overly long walls on certain building types which reduce walkability and do not establish a human scale. It ensures adequate room for pedestrians to move between structures, and provides access to light and air for each structure.

Space Between Buildings applies to: Cottage Court, Rowhouse, Flats, Mixed-Use B/Commercial

Common Courtyard Dimensions:

This design standard is intended to ensure that the common courtyard of the Cottage Court building form is located at a central point between each individual unit and provides ample shared outdoor space for all residents. Common courtyard dimension requirements also establish a common courtyard of a minimum size that will provide ample light and air access and privacy for each unit. The common courtyard should provide a space for residents to interact and promote a shared sense of community. While the Cottage Court building form may still provide small side and rear yards for each individual home, the common courtyard seeks to provide shared open space in lieu of larger, private yards.

Common Court Dimensions Applies to: Cottage Court

Building Alignment:

This standard is intended to strengthen the visual relationship between buildings and streets to create an engaging streetscape and discourages orientation of a building that is inconsistent with neighboring and nearby properties. Placing a building parallel to the street helps to frame the street space. Buildings placed parallel to the street promote interaction between buildings and pedestrians.

Building Alignment applies to: Single-Family A, Single-Family B, Two-Family, 3-Plex/4-Plex/Mansion Apartment, Cottage Court, Rowhouse, Flats, Mixed-Use A, Mixed-Use B/Commercial

Garage and Carport Location:

This standard is intended to prevent unarticulated garage doors close to the street and ensure garages are subordinate to the primary building. This design standard seeks to minimize the visibility and prominence of the garage and carport as viewed from the street. Property owners should seek to locate garages behind primary buildings along alleys where feasible so that the primary building is highlighted. Where locating the garage behind the primary building is not feasible or required, designs should minimize the visibility of garage doors as viewed from the street. This design standard is measured from the front property line to the garage or carport structure, regardless of the structure's orientation. Many building forms also indicate that garage and carports should be accessed from the alley when possible.

Garage and Carport Location applies to: Single-Family A, Single-Family B, Two-Family, 3-Plex/4-Plex/Mansion Apartment, Cottage Court, Rowhouse

Access and Driveway Width:

This standard is intended to minimize potential conflicts between pedestrians and vehicles by concentrating parking along alleys and away from the street, when possible. Properties with alleys shall utilize the alley as an opportunity to place the garage in a location that does not conflict with sidewalks. Where alley access is not possible, driveway widths should be minimized to decrease potential conflicts between pedestrians and vehicles where a driveway crosses a public sidewalk. This standard is also intended to limit overly wide pavement areas that are inconsistent with the rhythm of yards and buildings along a block.

Access and Driveway Width applies to: Single-Family A, Single-Family B, Two-Family, 3-Plex/4-Plex/Mansion Apartment, Cottage Court, Rowhouse, Flats, Mixed-Use A, Mixed-Use B/Commercial

Parking Location:

This design standard is intended to minimize the visibility of off-street surface parking from the street to promote an engaging and attractive streetscape. Where possible, parking should be located completely behind a primary building so that it is not visible from the street.

Parking Location applies to: Cottage Court, Mixed-Use A, Flats, Mixed-Use B/Commercial

Parking Access:

This standard intends to limit the number of access points to a development in order to minimize the visibility of parking and to maintain a built street wall. Parking access focuses specifically on those corridors within the DROD that should be the most oriented towards pedestrians.

Minimizing the number of entry and exit points for cars reduces potential conflict points with pedestrians, maintains a street wall along primary streets and maximizes opportunities on along the sidewalk for additional pedestrian amenities.

Parking Access applies to: Mixed-Use B

Accessory Dwelling Unit (ADU) Location:

The design standard is intended to minimize the visibility of an Accessory Dwelling Unit from the street and ensure that the ADU is subordinate to the primary building.

Accessory Dwelling Unit (ADU) Location applies to: Single-Family A (Area 3 only)

BUILDING FORM

Standards in the “Building Form” category are intended to ensure that the basic parameters of a building’s 3-dimensional volume are articulated and shaped to fit with the intent of a given DROD Area. Requirements focus on the basic scale and dimensions of a building “envelope”, including overall maximum building height and building length. Dimension and shape of smaller, individual building components, such as roofs or floors, are also addressed. “Building form” standards ensure that an overall building mass and its key components are sized, shaped and proportioned in a manner that is consistent and compatible with neighboring properties.

Front Wall Width:

This design standard is intended to create a consistent horizontal rhythm of similarly dimensioned front wall elements along a street by minimizing the width of the front wall to reflect the surrounding context of existing structures. It seeks to prevent the construction of long, horizontally-oriented walls along the street that are inconsistent with other detached single-family homes in an Area. Figure 4.12 below illustrates how to apply the Front Wall Width design standard requirements: The total permitted front wall width is noted by the letter “A”. Only “C” feet of the total front wall width (“A”) can be located within “B” feet of the front lot line. “C” is also known as the “front-most wall” of a building. Consult design standards for the proposed building form to determine exact widths and depths that apply to the explanation above.

Front Wall Width applies to: Single-Family A, Single-Family B, Two-Family, 3-Plex/4-Plex/Mansion Apartment, Cottage Court, Rowhouse

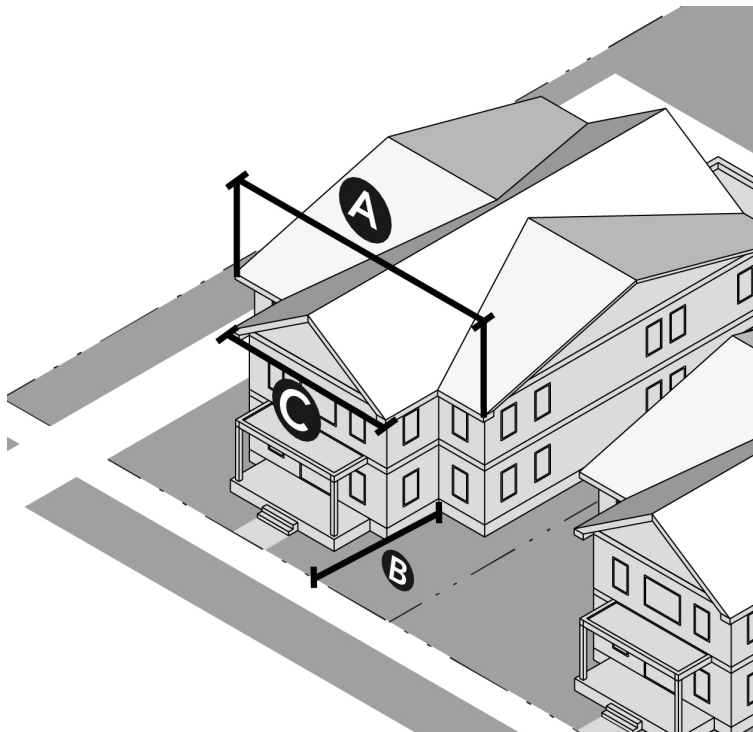

Figure 4.12

Wall Length:

This design standard is intended to prevent overly long buildings that prevent visual permeability into a site from the street and do not express a human scale consistent with other buildings in Downtown Broken Arrow. This design standard also seeks to break up continuous walls on longer blocks.

Wall Length applies to: Flats, Mixed-Use A, Mixed-Use B/Commercial

Building Height:

This design standard intends to establish overall heights of new structures that respond to surrounding lower scale areas while allowing for taller buildings that contribute to the active, urban environment envisioned for Downtown. This design standard also promotes scale that is compatible with Broken Arrow and ensures access to light and air.

Building Height applies to: Single-Family A, Single-Family B, Two-Family, 3-Plex/4-Plex/Mansion Apartment, Cottage Court, Rowhouse, Flats, Mixed-Use A, Mixed-Use B/Commercial

Finished Floor Height:

The finished floor design standard seeks to establish a separation between the public realm and private buildings by setting the first floor up off the ground, and to match the traditional form of raised porches. Figure 4.13 below shows the Finished Floor Height of a single-family residential building in blue.

Finished Ground Floor Level applies to: Single-Family A, Single-Family B, Two-Family, Cottage Court, Rowhouse, Flats, Mixed-Use A, Mixed-Use B/Commercial

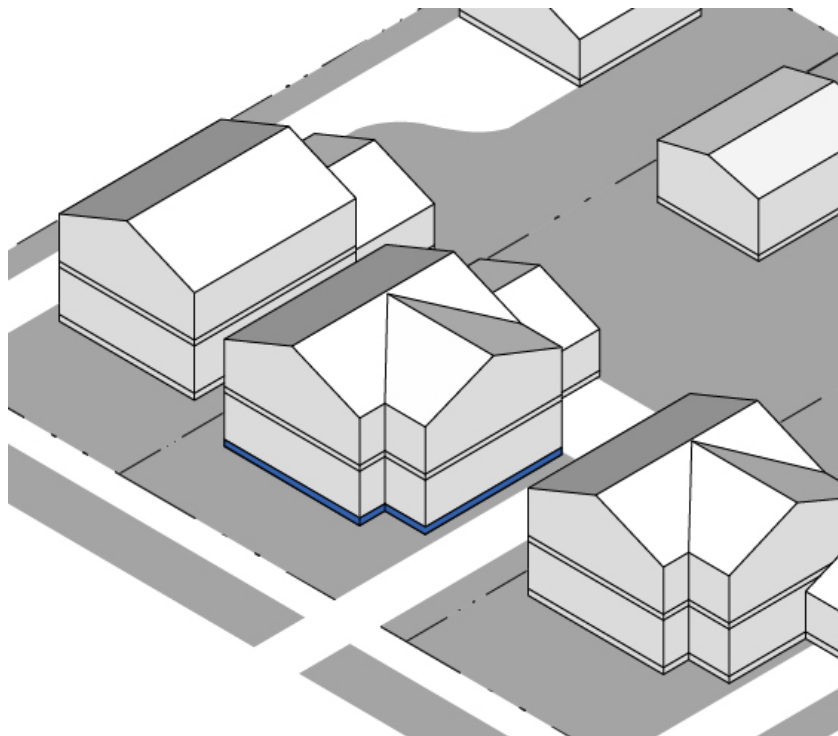

Figure 4.13

Floor Height:

This design standard seeks to establish consistent ranges of heights of individual floors within each Area in order to maintain visual continuity along a street. This also seeks to establish adequate height to support quality space for tenants or owners that is also in the range of traditional floor dimensions, which is particularly important in Downtown, Area 6. Floor height is measured as the vertical distance from the top of a floor's structure to the lowest point of the ceiling of that same floor.

Floor Height applies to: Single-Family A, Single-Family B, Two-Family, 3-Plex/4-Plex/Mansion Apartment, Cottage Court, Flats

Roof Form:

This design standard aims to create a consistent use of roof forms throughout an Area to provide visual consistency, and to provide for architectural variety in other Areas. The use of a given roof form will either maintain consistency in architectural form or support variety, depending on how the standard is applied in a given DROD Area.

Roof Form applies to: Single-Family A, Single-Family B, Two-Family, 3-Plex/4-Plex/Mansion Apartment, Cottage Court, Rowhouse, Flats, Mixed-Use A, Mixed-Use B/Commercial

Accessory Dwelling Unit (ADU) Building Height:

This standard is intended to promote Accessory Dwelling Units (ADUs) in Area 3 that are visually compatible with and subordinate to their primary buildings, as well as buildings on their neighboring lots. Providing a maximum height for an ADU promotes scale that is compatible with Broken Arrow and ensures access to air and light.

ADU Building Height applies to: Single-Family A

Accessory Dwelling Unit (ADU) Roof Form:

This standard is intended to promote Accessory Dwelling Units (ADUs) in Area 3 that are visually compatible with and subordinate to their primary buildings, as well as buildings on their neighboring lots. Regulating the roof form of an ADU aims to create a range of roof forms that are consistent with the primary structure, while also providing some architectural variety.

ADU Roof Form applies to: Single-Family A

Garage and Carport (if visible):

This standard seeks to minimize the presence of garages that are visible from the street. It is also intended to ensure that a garage is subordinate to the primary building. This will contribute to street level interest, thereby increasing walkability.

Garage and Carport applies to: Single-Family A, Single-Family B, Two-Family, Flats

Garage and Carport Width:

This standard is intended to promote garages and carports that are visually compatible with and subordinate to their primary buildings, as well as the buildings on neighboring lots. Overly wide garages and carports overwhelm the fronts of primary and accessory buildings, creating spaces void of architectural detail, which minimizes street level interest and detracts from the pedestrian experience.

Garage and Carport Width applies to: Single-Family B and Two-Family

Garage Door/Carport Height:

This standard is intended to promote garages and carports that are visually compatible with and subordinate to their primary buildings, as well as the buildings on neighboring lots. It promotes scale that is compatible with Broken Arrow and ensures access to air and light. Garages and carports that are too tall can detract from the overall appearance of a primary or accessory building.

Garage and Carport Height applies to: Single-Family A, Single-Family B, and Two-Family

BUILDING ACTIVATION

Standards in the “Building Activation” category focus on the more detailed 3-dimensional elements and architectural features on a building. They are intended to ensure that buildings establish a strong visual and physical relationship with the public realm, thereby enhancing walkability and visual interest. As such, standards in this category focus on minimizing blank, lifeless walls and other monotonous features, particularly along a public street. They promote visual connectivity between a building and a street by requiring regularly spaced entries along the street, encouraging windows and storefronts that allow visual permeability into a building, and ensuring that entry elements are visually and physically connected to the street.

First Story Element:

This standard seeks to establish smaller scale building features along the street that express the division between lower and upper floors on front facades to reduce perceived mass on multi-story buildings. Buildings should provide visual evidence or demarcation of the stories of a building to relate to pedestrians and express a human scale. Figure 4.14 below illustrates one example of a Shared First Story Element, in this case, a projecting porch, that is permitted for the Two-Family Building Form.

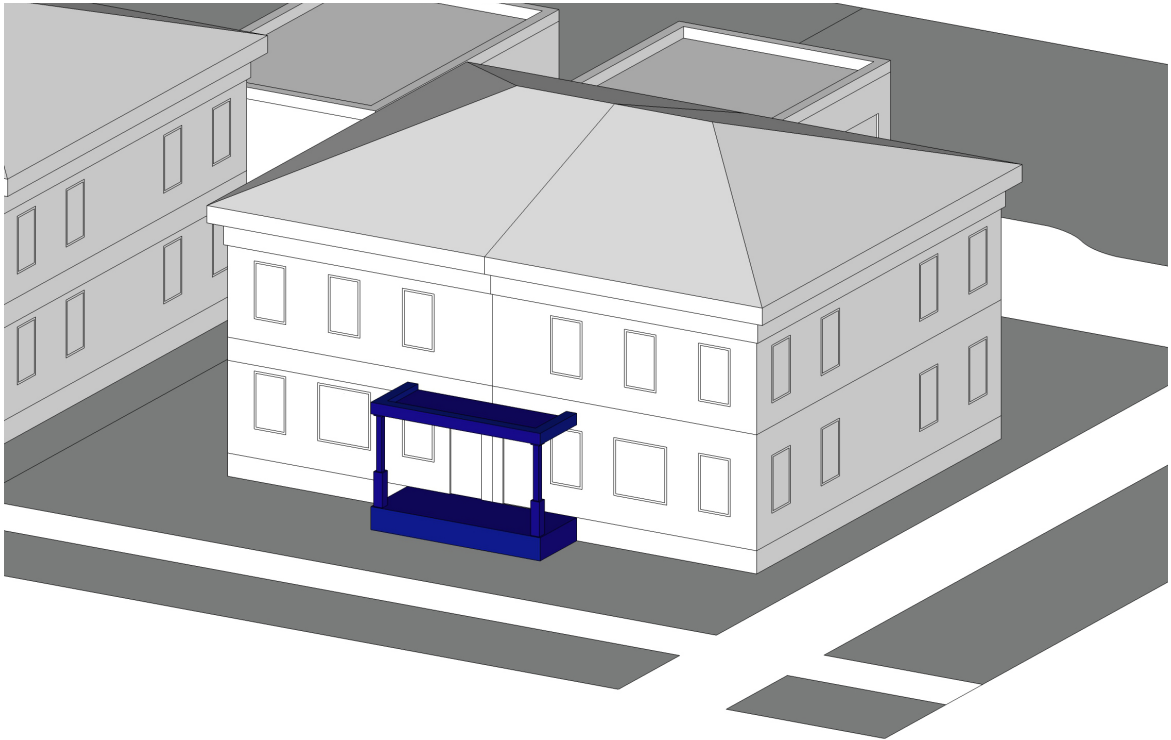

Figure 4.14

Blank Street-Facing Wall:

This standard is intended to reduce the overall perceived mass and bulk of buildings on a property as viewed from the street and establish a visual relationship between a building and the street. Designs should articulate building walls by using design techniques and including windows and doors to break up large, expansive wall planes. This standard seeks to enhance street-level pedestrian interest, establish visual continuity along a street and create visual connectivity between the street and a private property.

The blank street-facing wall distance is measured on each individual floor of a building, horizontally between windows and doors. When measuring, the windows and doors vertically extend to cover the floor being measured, creating a Vertical Window/Door Area, as shown in Figure 4.15. Therefore, the blank wall distance is measured horizontally between the established Vertical Window/Door Areas on one floor. These distances are always measured from the elevation view of the building. Figure 4.17 illustrates how to measure the blank street-facing wall. Each building type in Chapter 5 specifies the numeric value of the maximum blank street-facing wall distance that is allowed between windows and doors.

Street-Facing Facade Design applies to: Single-Family A, Single-Family B, Two-Family, 3-Plex/4-Plex/Mansion Apartment, Cottage Court, Rowhouse, Flats, Mixed-Use A, Mixed-Use B/Commercial

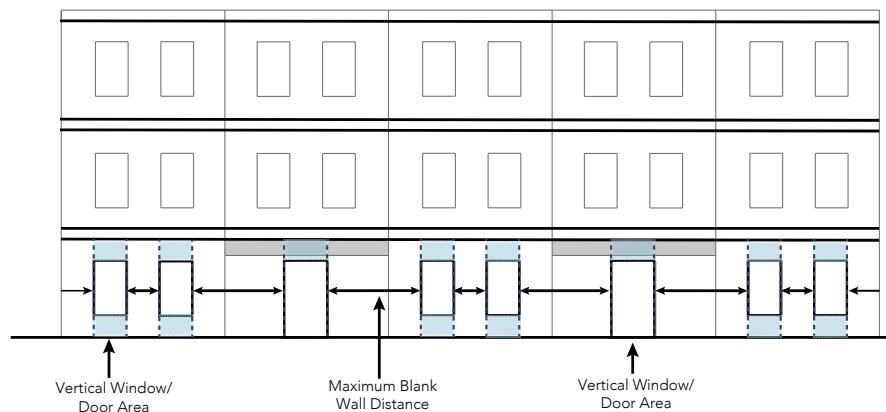

Figure 4.15

Principal Windows:

Principal windows are one of the most important character defining elements of a building’s street-facing wall. Windows are one of the primary opportunities for breaking up large, expansive wall planes and allowing air and light into a structure. Incorporating principal windows also helps create a human scale and enhance street level interest. Principal windows help create visual connectivity between the street and a private property. This standard sets the minimum number of principal windows that should appear on a building’s street-facing wall, as well as the minimum size of those windows.

Principal Windows applies to: Single-Family A, Single-Family B, Two-Family, 3-Plex/4-Plex/Mansion Apartment, Cottage Court, and Rowhouse

Window Size – Street-facing Wall:

This standard is intended to encourage the use of appropriately sized windows on the street-facing wall of a building. Windows are one of the primary opportunities for breaking up large, expansive wall planes and allowing air and light into a structure. Incorporating windows in addition to the principal window also helps create a human scale and enhance street level interest.

Window Size – Street-facing Wall applies to: Single-Family A, Single-Family B, Two-Family, 3-Plex/4-Plex/Mansion Apartment, Cottage Court, and Rowhouse

Entry Presence – Facing Street:

The entry presence is one of a group of standards that intends to establish a relationship between a primary building’s entrance and the street. It also seeks to establish visual continuity along the street with a rhythm of clearly demarcated entries. Figure 4.16 below illustrates an entrance that opens onto a porch rather than toward the public realm, which is one of the ways that may be appropriate for a building to visually connect an entrance to the street.

Entry Presence – Facing Street applies to: Single-Family A, Single-Family B, Two-Family, 3-Plex/4-Plex/Mansion Apartment, Cottage Court, Rowhouse, flats, Mixed-Use A, and Mixed-Use B/Commercial



Figure 4.16

Entry Location (On Street-Facing Wall):

The entry location is one of a group of standards regarding entry design that intends to establish a relationship between a primary building’s entrance and the street. It also seeks to establish visual continuity along the street with a rhythm of clearly demarcated entries. Figure 4.17 below illustrates an entry that is located setback from the front-most wall. The permitted distance of this setback depends on the building form.

Entry Location (On Street-Facing Wall) – Facing Street applies to: Single-Family A, Single-Family B, Two-Family, 3-Plex/4-Plex/Mansion Apartment, Cottage Court, Rowhouse



Figure 4.17

Entry Number (On Street-Facing Wall):

The number of entries is one of a group of standards regarding entry design that intends to establish a relationship between a primary building's entrance and the street. It also seeks to establish visual continuity along the street with a rhythm of clearly demarcated entries. Requiring this intends to provide continuity along a street and to provide access points throughout a larger development.

Entry Number applies to: 3-Plex/4-Plex/Mansion Apartment

Entries per Unit:

This standard is one of a group of standards regarding entry design that intends to establish a relationship between a primary building's entrance and the street, and between the entries in a rowhouse development. This standard establishes a minimum number of entries per rowhouse unit. It reinforces that rowhouses should be individual units with their own entries, as opposed to other multi-family building forms that rely on shared public entrances.

Entries per Unit applies to: Rowhouse

Entry Path:

The entry path is one of a group of standards regarding entry design that intends to establish a relationship between a primary building's entrance and the street. It also seeks to establish visual continuity along the street with a rhythm of clearly demarcated entries. Requiring a physical connection from the entry of a building to the street creates a clear space to enter a site and visually relates a building to the public realm.

Entry Path applies to: Single-Family A, Single-Family B, Two-Family, Cottage Court, 3-Plex/4-Plex/Mansion Apartment, Rowhouse, Flats, Mixed-Use A

Distance Between Entries:

The distance between entries is one of a group of standards regarding entry design that intends to establish a relationship between a primary building's entrance and the street. It also seeks to establish visual continuity along the street with a rhythm of clearly demarcated entries. Requiring a maximum distance between entries intends to provide a distance that is easily traveled by a pedestrian and a distance that creates a pedestrian-scale of development.

Distance Between Entries applies to: Flats, Mixed-Use A, Mixed-Use B/Commercial

Building Articulation Options:

This design standard is intended to reduce perceived building mass as viewed from the street by breaking the scale of the building into components that express a human scale. A complete list of building articulation options can be found in the Appendix along with definitions and visual examples.

Building Articulation Options applies to: Flats, Mixed-Use B/Commercial

Active Retail Storefront (Mixed-Use A) :

This design standard seeks to minimize retail uses and activity in Mixed-Use A buildings in Area 5 to promote compatibility with adjacent residential focused uses.

Active Retail Storefront applies to: Mixed-Use A

Ground Floor Transparency:

Ground-floor transparency intends to establish a minimum percentage of void (windows, doors, etc.) along the ground-floor in order to create street level interest and visual connectivity between the street and the property. Requiring a minimum amount of ground-floor transparency also ensures access to light and air. Ground-floor transparency is calculated based on the total façade area located between two (2) feet and twelve (12) feet above the finished ground-floor level. Figure 4.18 illustrates the area within which ground-floor transparency is measured, and highlights the windows and doors in blue that contribute to the calculation.

Parking Screening applies to: Mixed-Use B/Commercial

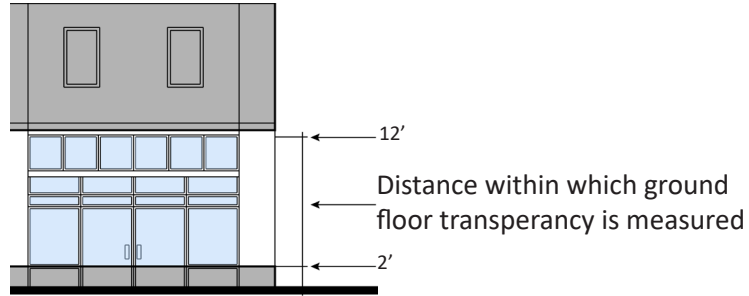

Figure 4.18

Parking Screening:

This design standard is intended to minimize the visibility of surface parking lots located adjacent to the street to maintain an attractive and pedestrian-friendly streetscape. Figures 4.19, 4.20 and 4.21 illustrate a variety of parking screening options that may be utilized when a parking lot is visible from the street. Parking screening options include landscaping, constructing a wall or constructing a fence.

Parking Screening applies to: Mixed-Use A, Mixed-Use B/Commercial

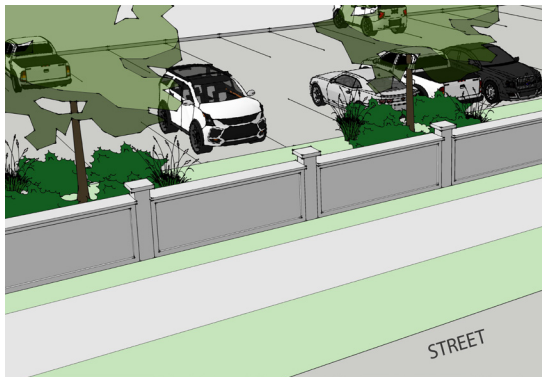

Figure 4.19 illustrates
Parking screening with wall.

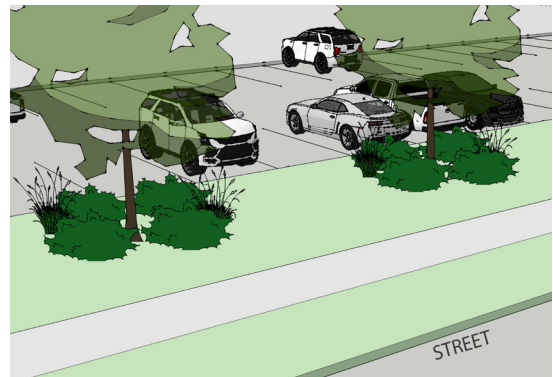

Figure 4.20 illustrates
Parking screening with landscape.

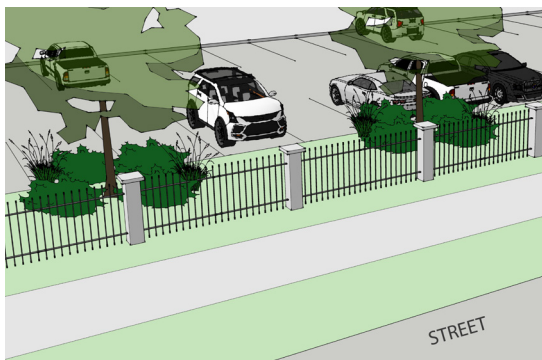

Figure 4.21 illustrates
Parking screening with fence.

V. DESIGN STANDARDS BY BUILDING FORM

The design standards are written by Building Form. The design variables for each of the nine Building Forms are divided into four categories: Lot, Site, Building Form and Building Activation. Design standards are written for each of the four categories. For those Building Forms that are permitted in multiple Areas, specific design standards are provided for each design variable based on Area. After the design standards for one category are provided, an annotated model illustrates the previously presented design standards. Annotations in each model correspond to the letter(s) shown on each design variable table.

The four categories that the design variables for each building form are divided into are described below:

Lot

Standards in the “Lot” category are intended to ensure that a site is adequately sized and dimensioned to accommodate a particular building form, consistent with the intent of the DROD Area in which it is located. Lot dimension requirements help ensure that a consistent and compatible horizontal rhythm of buildings is established along a public street and that a project with multiple units or buildings on one lot does not appear overly dense in relation to residential properties nearby. Lot requirements are particularly important in areas where single-family homes are prominent.

Where a site will be subdivided into more than one parcel (a potential situation for Rowhouse, Cottage Court, Two-Family and 3-Plex/4-Plex/Mansion Apartment), lot design standards should be based on the collective area of all parcels. Figures 4.1 and 4.2 illustrate a project site that remains 1 parcel, despite the individual rowhouse units. Figures 4.3 and 4.4 illustrate a project site that was subdivided into individual parcels based on units. While this project is subdivided, the lot design standards should still be based on the collective area of all parcels.

Site

Standards in the “Site Design” category are intended to ensure that the arrangement and relationship between various elements on a site have a positive impact on the property and the surrounding neighborhood. Site standards identify where buildings, parking and other elements should be located on a site to promote a visually cohesive neighborhood, establish a rhythm of buildings along a street, minimize the visual impact of parking and garages on the neighborhood and ensure that sufficient light, air and privacy are preserved between adjoining properties. They also promote efficient and safe circulation of pedestrians and vehicles, as well as a minimization of pedestrian/vehicle conflicts.

Where a site will be subdivided into more than one parcel (a potential situation for Rowhouse, Cottage Court, Two-Family and 3-Plex/4-Plex/Mansion Apartment), site design standards should be based on the collective area of all parcels. Figures 4.5 and 4.6 illustrate a project site that remains 1 parcel, despite the individual rowhouse units. Figures 4.7 and 4.8 illustrate a project site that was subdivided into individual parcels based on units. While this project is subdivided, the site design standards should still be based on the collective area of all parcels.

Building Form

Standards in the “Building Form” category are intended to ensure that the basic parameters of a building’s 3-dimensional volume are articulated and shaped to fit with the intent of a given DROD Area. Requirements focus on the basic scale and dimensions of a building “envelope”, including overall

maximum building height and building length. Dimension and shape of smaller, individual building components, such as roofs or floors, are also addressed. “Building form” standards ensure that an overall building mass and its key components are sized, shaped and proportioned in a manner that is consistent and compatible with neighboring properties.

Building Activation

Standards in the “Building Activation” category focus on the more detailed 3-dimensional elements and architectural features on a building. They are intended to ensure that buildings establish a strong visual and physical relationship with the public realm, thereby enhancing walkability and visual interest. As such, standards in this category focus on minimizing blank, lifeless walls and other monotonous features, particularly along a public street. They promote visual connectivity between a building and a street by requiring regularly spaced entries along the street, encouraging windows and storefronts that allow visual permeability into a building, and ensuring that entry elements are visually and physically connected to the street.

Any requests for variances to the requirements for “Lot” and “Site” must be reviewed and approved by the Board of Adjustment in accordance with Section 6.8. Requests for variances to the requirements associated with “Building Form” at “Building Activation” shall be considered and approved by the Planning Commission through the site plan review process.

SINGLE-FAMILY A

DESCRIPTION

The “Single-Family A” building form is a detached house that is a small-scale, freestanding building, typically 1 to 2.5 stories in height. This form occurs as a single building on a lot and it may include building details such as a front porch, front stoop and attached or detached garage. This type of single-family home is typically set back from the public right of way and adjacent lots, and is slightly elevated above the ground. It typically includes a moderately pitched roof form and is designed with the smaller dimension of the building footprint parallel to the street. In some cases, a flat roof shape is employed. This building form is ideally designed to facilitate residential uses.

Permitted in Areas 1, 2, 3, and conditionally permitted in Area 5*

* Single-Family A is conditionally permitted in Area 5 when single-family context is appropriate and where it aligns with the City’s land use vision. In those cases, projects should adhere to Area 1 standards.



LOT

A Lot Area		
Area 1	5,000 sq.ft. Min. ¹	
Areas 2 & 3	5,500 sq.ft. Min. ¹	
B Lot Frontage		
Area 1	25' Min. 75' Max	
Areas 2 & 3	35' Min. 80' Max	
C Lot Coverage		
Area 1, 2 & 3	55% Max	

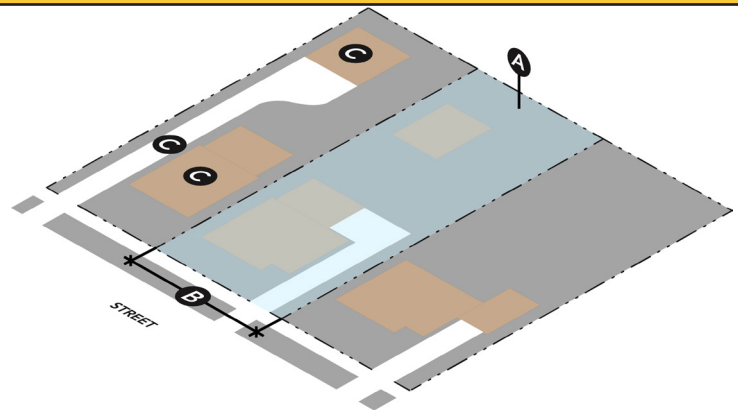

Additional Information

1. Existing lots 30' wide or less: 3,500 sq. ft. Min.

SITE

A Front Setback/Build to Zone (BTZ)		
	Area 1	10' Min./65% in BTZ ¹
	Area 2 & 3	15' Min./65% in BTZ ¹
B Side Setback		
	Area 1	5' Min., Transitional Setback Required ^{2&3}
	Areas 2 & 3	5' Min., Transitional Setback Required ³
C Rear Setback		
	Area 1, 2 & 3	10' Min., Transitional Setback required ^{3&4}
D Building Alignment		
	Area 1, 2 & 3	Required ⁵
E Garage and Carport Location		
	Area 1	30' Min. setback from front property line
	Area 2	35' Min. setback from front property line
	Area 3	Front of garage/carport must be placed behind rear wall of primary structure
F Access and Driveway Width		
	Areas 1 & 2	25' Max. ^{6&7}
	Area 3	25' Max. ⁸
G Accessory Dwelling Unit (ADU) Location		
	Area 1, 2 & 3	Front of ADU must be placed behind rear wall of primary structure

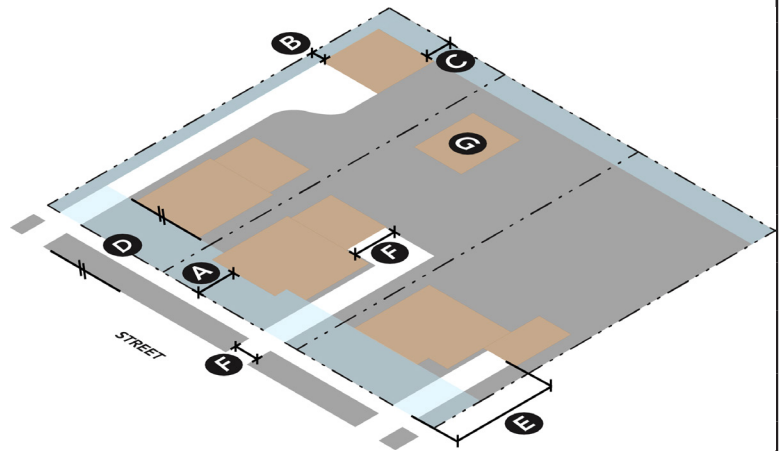

Additional Information

Note: Sidewalks shall be provided along all street frontages in accordance with the Subdivision Regulations.

- 1 65% of front wall is required to be placed within 10' of required front setback.
- 2 Existing lots 30' wide or less: 3' side setback
- 3 For buildings above 1 story, the 2nd story and above must be set back an additional 5' from the shared lot line. This requirement applies on all side and rear lot lines except where otherwise stated or where the property abuts a lot in Area 5, 6 or 7.

4 If an alley is present, rear setback is 2' min.

5 Building Alignment

Interior Lot: front wall of primary structure shall be parallel to the street

Corner Lot: All or any visible street-facing wall must be placed parallel to the adjacent street.

6 Only 18' wide until driveway is within 20' of garage entry

7 Where feasible, provide access from an alley

8 If an alley is present, access must be provided from the alley

SINGLE-FAMILY A

BUILDING FORM

A Front Wall Width		
Area 1	45' Max. ¹	
Area 2	50' Max. ²	
Area 3	50' Max. ³	
B Building Height		
Areas 1, 2 & 3	2.5 stories/35' Max. ⁴	
C Finished Floor Height		
Areas 1, 2 & 3	1' Min.; 4' Max.	
D Floor Height		
Areas 1, 2 & 3	9' Min.	
E Roof Form		
Area 1	Pitched or flat	
Areas 2 & 3	Pitched	
F Garage and Carport Width		
Areas 1, 2 & 3	25' or 40% width of primary structure: max. street-facing garage door width ⁵	
G Garage Door/Carport Height		
Areas 1, 2 & 3	9' Max. garage door/carport height	
H Garage and Carport (If Visible)		
Areas 1, 2 & 3	If any portion of the garage is located forward of the rear wall of primary structure: - Roof of garage or carport must match roof of primary structure - Height of garage or carport must be equal to or less than the height of primary structure	
I ADU Building Height		
Areas 1 & 2	N/A	
Areas 3	1 story/15' Max.	
J ADU Roof Form		
Areas 1, 2 & 3	Must match primary structure	

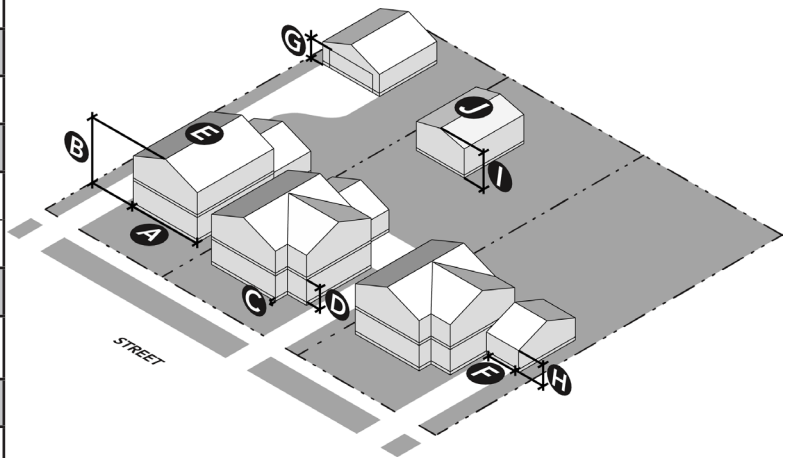

Additional Information

- 1 Only 30' of total front wall width can be located within 25' of the front lot line
- 2 Only 40' of total front wall width can be located within 30' of front lot line.
- 3 Only 40' of total front wall width can be located within 25' of front lot line
- 4 If a half story is above floor 2, the half story must be contained within the roof.
- 5 Exception for existing lots 30' wide or less

BUILDING ACTIVATION

A First Story Element		
Area 1	Not Required	
Area 2	Required ^{1&3}	
Area 3	Required ^{2&3}	
B Principal Windows		
Areas 1, 2 & 3	1 Min. on front-most wall 4'x4' Min. dimensions	
C Blank Street-Facing Wall		
Areas 1, 2 & 3	8' Max.	
D Window Size - Street-Facing Wall		
Areas 1, 2 & 3	2'x3', except for an accent window	
E Entry Location (On Street-Facing Wall)		
Areas 1, 2 & 3	10' Max. distance of entry from front-most wall	
F Entry Presence - Facing Street		
Areas 1 & 2	Required ⁴	
Area 3	Entry must face the primary street	
G Entry Path		
Areas 1, 2 & 3	Required ^{5&6}	

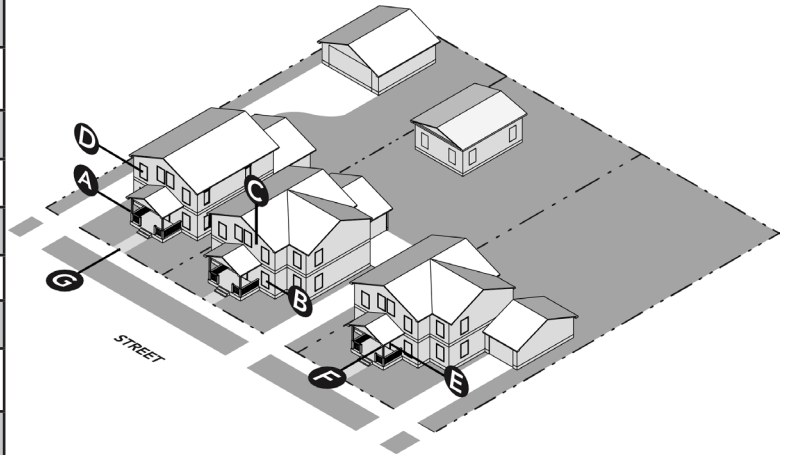

Additional Information

1 Must include one of the following elements:

- Projecting Porch
- Recessed Porch
- Projecting Stoop

2 Must include one of the following elements:

- Projecting Porch
- Recessed Porch

3 Height of first story element must have an interior clearance of at least 8 feet, no greater than 12 feet. Interior clearance is measured from the floor of the first story element to the lowest point of the ceiling of the first story element.

4 In Areas 1 and 2, visually connect entrance to street through one of the following:

- Entry faces street
- Entry opens onto porch or stoop that faces street

5 Must connect at least one entry to street through physical, demarcated path

6 Exception for existing lots 30' wide or less — not required

SINGLE-FAMILY B

DESCRIPTION

The “Single-Family B” building form is a detached house that is typically one-story in height. This form occurs as a single building on a lot. This free-standing building is typically set back from the public right of way and adjacent lots, and is slightly elevated above the ground. A small porch or stoop brings attention to the primary entrance to the single-family building. The single- or double-car garage is generally attached to the primary structure, most often placed flush with the front-most wall of the building. It typically includes a low-pitched roof form and is horizontally aligned to the street. This building form is ideally designed to facilitate residential uses.



Permitted in Area 4

LOT

A Lot Area		
	Area 4	6,000 sq.ft. Min.
B Lot Frontage		
	Area 4	55' Min. 120' Max
C Lot Coverage		
	Area 4	50% Max

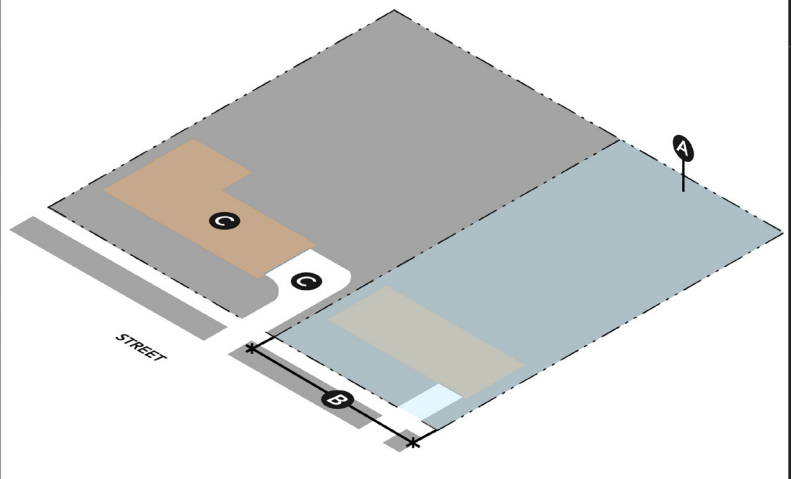

SITE

A Front Setback/Build to Zone (BTZ)		
Area 4		20' Min. /75% BTZ ¹
B Side Setback		
Area 4		5' Min.
C Rear Setback		
Area 4		10' Min.
D Building Alignment		
Area 4		Required ²
E Garage and Carport Location		
Area 4		20' Min. ³
F Access and Driveway Width		
Area 4		25' Max.

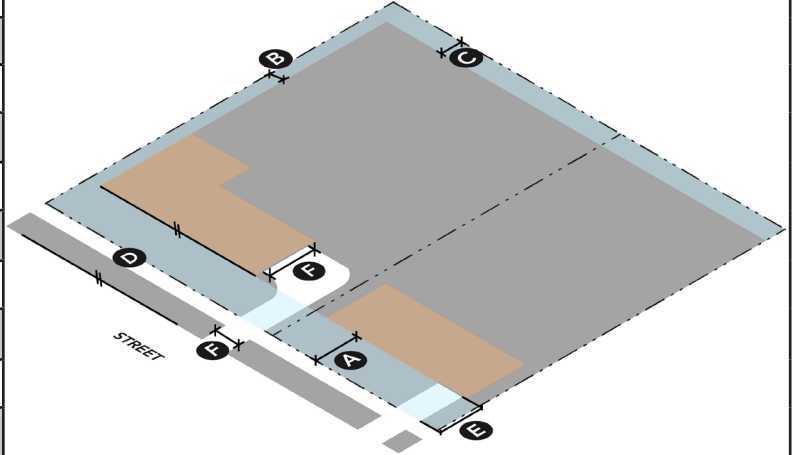

Additional Information

Note: Sidewalks shall be provided along all street frontages in accordance with the Subdivision Regulations.

1 75% of front wall is required to be placed within 10' of required front setback.

2 Building Alignment
Interior Lot: front wall of primary structure shall be parallel to the street

Corner Lot: All or any visible street-facing wall must be placed parallel to the adjacent street.

3 Garage and carport shall not project forward from front-most wall of primary structure

SINGLE-FAMILY B

BUILDING FORM

A Front Wall Width		
Area 4		45' Min, 80' Max
B Building Height		
Area 4		1 story/20' Max. within 35' of front property line 2 stories/30' Max. beyond 35' of front lot property line
C Finished Floor Height		
Area 4		1' Min, 3' Max
D Floor Height		
Area 4		9' Min.
E Roof Form		
Area 4		Pitched
F Garage and Carport Width		
Area 4		25' or 30% width of primary structure: max. street-facing garage door width
G Garage Door/Carport Height		
Area 4		9' Max. garage door or carport height ¹

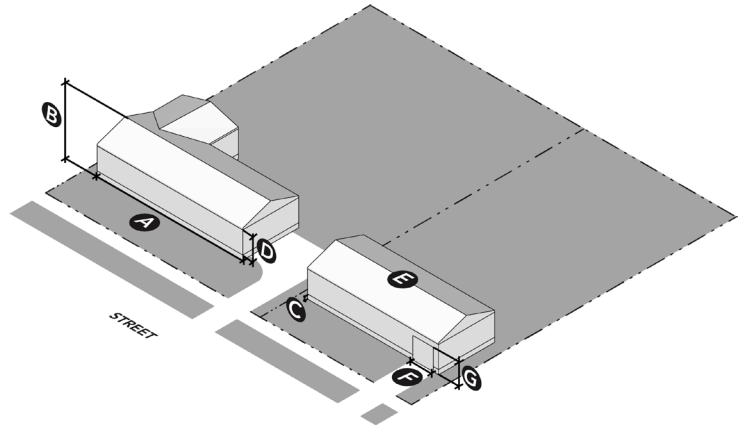

Additional Information

- 1 If any portion of the garage is located forward of the rear wall of primary structure:
- Roof of garage or carport must match roof of primary structure
 - Height of garage or carport must be equal to or less than the height of primary structure

BUILDING ACTIVATION

A First Story Element		
Area 4	Required ^{1&2}	
B Principal Windows		
Area 4	2 Min. on front wall 4'x4' Min. dimensions	
C Blank Street-Facing Wall		
Area 4	8' Max.	
D Window Size - Street-Facing Wall		
Area 4	2'x3', except for an accent window	
E Entry Location (On Street-Facing Wall)		
Area 4	10' Max. distance of entry from front-most wall	
F Entry Presence - Facing Street		
Area 4	Required ³	
G Entry Path		
Area 4	Required ⁴	

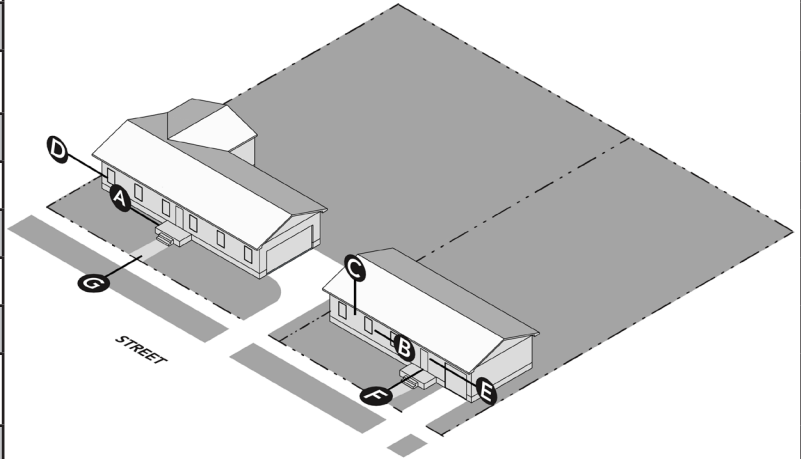

Additional Information

- 1 Must include one of the following elements:
- Projecting Porch
 - Recessed Porch
 - Projecting Stoop

- 2 Height of first story element must have an interior clearance of at least 8 feet, no greater than 12 feet. Interior clearance is measured from the floor of the first story element to the lowest point of the ceiling of the first story element.

- 3 Visually connect entrance to street through one of the following:
- Entry faces street
 - Entry opens on porch or stoop that faces street

- 4 Must connect to street through physical, demarcated path

TWO-FAMILY

DESCRIPTION

The “Two-Family” building form exhibits a similar shape and architectural features to the “Single-Family A” building form, but allows for a slightly higher density. The Two-Family building form can be designed as two side-by-side single-family units; can be a form split with one unit facing the primary street and the other facing a secondary street, backyard, or side yard; and can be a form with one unit on the ground-level and the other on the upper-level. Parking is provided for each of the units. Parking can take the form of a shared, attached garage; a shared, detached garage; individual, attached garages; or individual, shared garages.



Permitted Areas 1 & 2

LOT*

A Lot Area		
Area 1	6,500 sq.ft. Min.	
Area 2	7,500 sq.ft. Min.	
B Lot Frontage		
Area 1	110' Max., 45' Min.	
Area 2	130' Max., 55' Min.	
C Lot Coverage		
Area 1	60% Max	
Area 2	55% Max.	

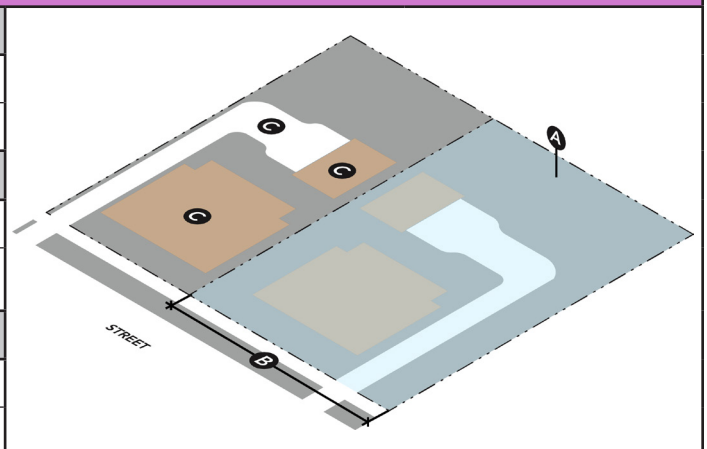

Additional Information

* Where a site will be subdivided into more than one parcel, lot and site design standards should be based on the collective area of all parcels.

SITE*

A Front Setback/Build to Zone (BTZ)		
Area 1	10' Min./65% BTZ ¹	
Area 2	15' Min./65% BTZ ¹	
B Side Setback		
Areas 1 & 2	5' Min., Transitional Setback Required ²	
C Rear Setback		
Area 1	10' Min., Transitional Setback Required ^{2&3}	
D Building Alignment		
Areas 1 & 2	Required ⁴	
E Garage and Carport Location		
Area 1	30' Min. setback from front property line	
Area 2	35' Min. setback from front property line	
F Access and Driveway Width		
Area 1	25' Max ^{5&6}	

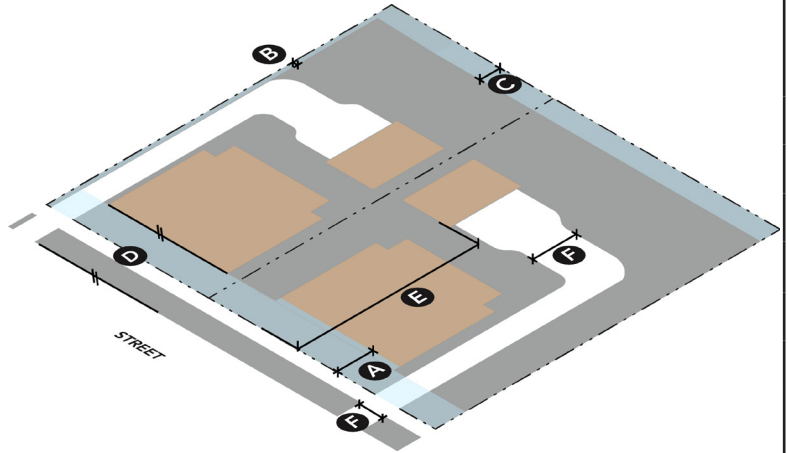

Additional Information

Note: Sidewalks shall be provided along all street frontages in accordance with the Subdivision Regulations.

* Where a site will be subdivided into more than one parcel, lot and site design standards should be based on the collective area of all parcels.

- 1 65% of front wall is required to be placed within 10' of required front setback.
- 2 For buildings above 1 story, the 2nd story and above must be set back an additional 5' from the shared lot line. This requirement applies on all side and rear lot lines except where otherwise stated or where the property abuts a lot in Area 5, 6 or 7.

- 3 If an alley is present, rear setback is 2' min.
- 4 Building Alignment
Interior Lot: front wall of primary structure shall be parallel to the street

Corner Lot: Both street-facing walls of the primary structure shall be parallel to each street
- 5 Only 18' wide until driveway is within 20' of garage entry
- 6 Where feasible, provide access from an alley

TWO-FAMILY

BUILDING FORM

A Front Wall Width		
Area 1	50' Max.	
Area 2	65' Max.	
B Building Height		
Areas 1 & 2	2 stories/35' Max.	
C Finished Floor Height		
Areas 1 & 2	1' Min, 4' Max.	
D Floor Height		
Areas 1 & 2	9' Min., 15' Max.	
E Roof Form		
Area 1	Pitched or flat	
Area 2	Flat	
F Garage and Carport Width		
Areas 1 & 2	25' or 40% width of primary structure: Max. street-facing garage door width.	
G Garage Door/Carport Height		
Areas 1 & 2	9' Max. garage door or carport height ¹	

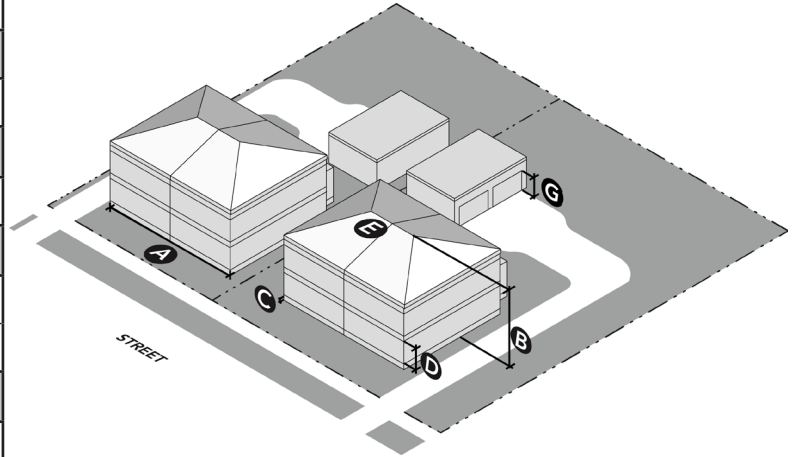

Additional Information

- 1 If any portion of the garage is located forward of the rear wall of primary structure:
- Roof of garage or carport must match roof of primary structure
 - Height of garage or carport must be equal to or less than the height of primary structure

BUILDING ACTIVATION

A First Story Element		
Areas 1 & 2	Required ^{1&2}	
B Principal Windows		
Areas 1 & 2	1 Min. on front-most wall 4'x4 dimensions ³	
C Blank Street-Facing Wall		
Areas 1 & 2	8' Max.	
D Window Size - Street-Facing Wall		
Areas 1 & 2	2'x3', except for an accent window	
E Entry Location (On Street-Facing Wall)		
Areas 1 & 2	10' Max. distance of entry from front-most wall	
F Entry Presence - Facing Street		
Areas 1 & 2	Required ⁴	
G Entry Path		
Areas 1 & 2	Required ⁵	

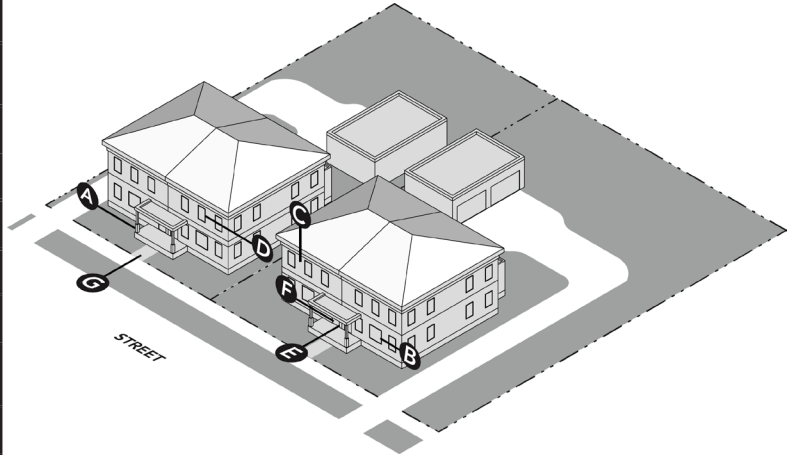

Additional Information

- 1 Must include one of the following elements:
 - Projecting Porch
 - Recessed Porch
 - Projecting Stoop (not permitted in Area 2)
 - Shared first story element
- 2 Height of first story element must have an interior clearance of at least 8 feet, no greater than 12 feet. Interior clearance is measured from the floor of the first story element to the lowest point of the ceiling of the first story element.
- 3 If street-facing wall is 35' or wider, must have 2 principal windows
- 4 Visually connect entrance to street through one of the following:
 - Entry faces street,
 - Entry opens on porch that faces street
- 5 Must connect to street through physical, demarcated path

COTTAGE COURT

DESCRIPTION

This building form consists of a series of small, detached structures, providing multiple units arranged around a common courtyard on one lot, which is oriented perpendicular to the street. The common courtyard provides usable, shared open space in lieu of a private rear yard and becomes an important community element. This building form is sized to fit within single-family and medium density neighborhoods. The Cottage Court building form enables appropriately scaled, well-designed higher densities and is important for providing a broad choice of housing types and promoting walkability. Parking in Cottage Court developments can occur in many fashions: as attached or detached garages tied to individual homes, as attached carports, within detached communal garages, or within scattered surface parking lots. Courtyards can also be jointly owned by the community or partitioned to individual owners.

Permitted in Area 1

Special Conditions:

1. This building form may not be built on a corner lot.
2. There must be a minimum of 3 units, and a maximum of 9 units in a cottage court building form.



LOT*

A Lot Area		
Area 1		10,000 sq.ft. Min.
B Lot Frontage		
Area 1		100' Min.
C Lot Depth		
Area 1		100' Min.
D Lot Coverage		
Area 1		60% Max.

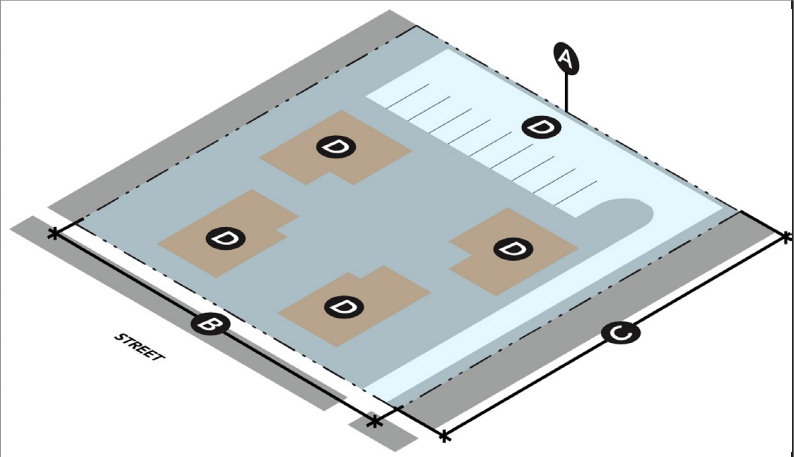

Additional Information

* Where a site will be subdivided into more than one parcel, lot and site design standards should be based on the collective area of all parcels.

SITE*

A Front Setback/Build to Zone (BTZ)		
Area 1		10' Min./75% BTZ ^{1&2}
B Side Setback		
Area 1		5' Min., Transitional Setback Required ³
C Rear Setback		
Areas 1		10' Min, Transitional Setback Required ^{3&4}
D Space Between Buildings		
Areas 1		10' Min.
E Common Courtyard Dimensions		
Areas 1		30'x40' Min.
F Building Alignment		
Area 1		Required ⁵
G Access and Driveway Width		
Area 1		20' Max.
H Garage and Carport Location		
Area 1		10' Min. setback from front property line ^{6&7}

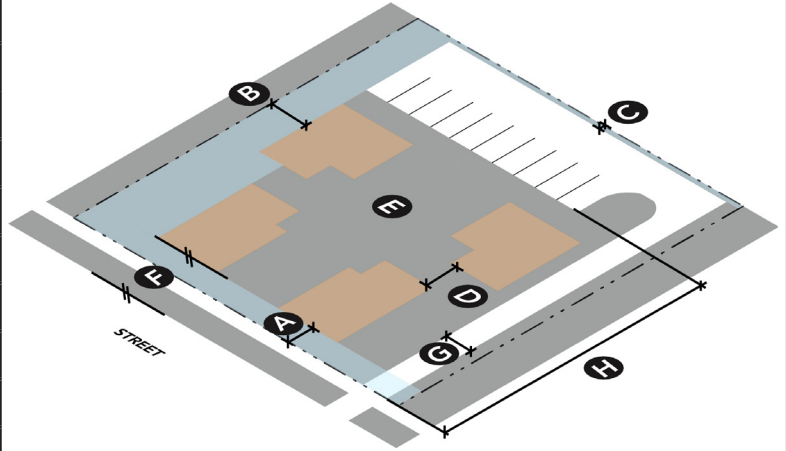

Additional Information

Note: Sidewalks shall be provided along all street frontages in accordance with the Subdivision Regulations.

* Where a site will be subdivided into more than one parcel, lot and site design standards should be based on the collective area of all parcels.

1 Applies to each wall that is parallel to the street and does not have a building between it and the street.

2 75% of front wall is required to be placed within 10' of required front setback

3 For buildings above 1 story, the 2nd story and above must be set back an additional 5' from the shared lot line. This requirement applies on all side and rear lot lines except where otherwise stated or where the property abuts a lot in Area 5, 6 or 7.

4 If an alley is present, rear setback is 2' min.

5 Street-facing walls on end units shall be parallel to street

6 No parking allowed between street-facing wall and street

7 Garage door and carport entry cannot face the street

COTTAGE COURT

BUILDING FORM

A Front Wall Width		
Area 1	70' Max. total 40' Max. for individual building wall	
B Building Height		
Area 1	2 stories/35' Max.	
C Finished Floor Height		
Area 1	1' Min., 4' Max.	
D Floor Height		
Area 1	9' Min., 15' Max.	
E Roof Form		
Area 1	Pitched or flat	

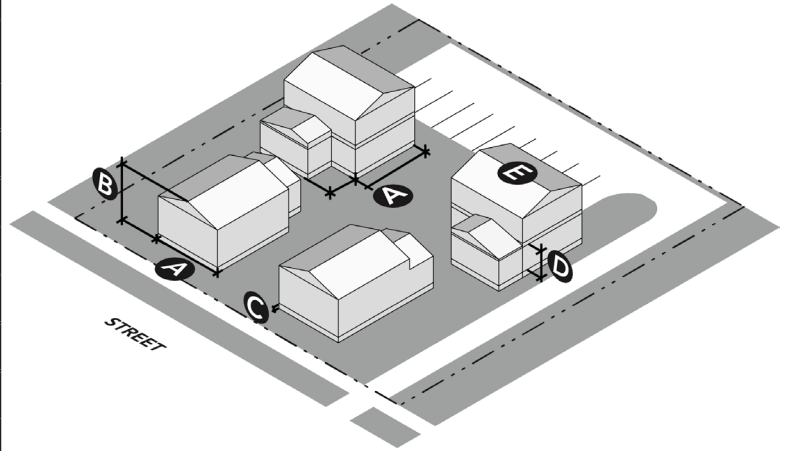

BUILDING ACTIVATION

A First Story Element		
Area 1	Required ¹ & ²	
B Principal Windows		
Area 1	1 Min. on front-most wall ³ 4'x'4 Min. dimensions	
C Blank Street-Facing Wall		
Area 1	8' Max.	
D Window Size - Street-Facing Wall		
Areas 1	2'x3' Min., except for accent windows.	
E Entry Location (On Street-Facing Wall)		
Area 1	10' Max distance of entry from front-most wall	
F Entry Presence - Facing Street		
Area 1	Required ^{4&5}	
G Entry Path		
Area 1	Required ⁶	

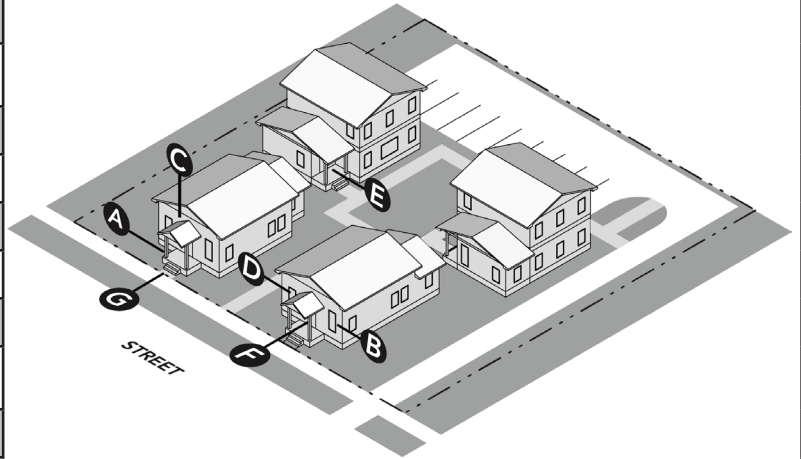

Additional Information

- Must include one of the following elements on the front-most façade of each unit:
 - Projecting Porch
 - Recessed Porch
- Height of first story element must have an interior clearance of at least 8 feet, no greater than 12 feet. Interior clearance is measured from the floor of the first story element to the lowest point of the ceiling of the first story element.
- If height of front wall is greater than 35', 2 principal windows are required
- Visually connect entrance to street through one of the following:
 - Entry faces street
 - Entry opens onto porch that faces street
- Street-adjacent buildings may visually connect to street instead of common courtyard
- Must connect to street through physical, demarcated path

3-PLEX/4-PLEX/MANSION APARTMENT

DESCRIPTION

A 3-Plex/4-Plex/Mansion Apartment building form provides an opportunity for increased density in a single-family context. While providing multiple units within one building, this building form appears to be similar in size and shape to that of a large single family house, utilizing a single roof, shared entry or entries and shared outdoor space. While this building form may be larger than neighboring single-family buildings, its setbacks, parking location and wall articulation features make it an appropriate building form that allows for increased density in the single-family context.



Permitted in Areas 1 & 5

LOT*

A Lot Area		
Areas 1 & 5	6,500 sq.ft. Min.	
B Lot Frontage		
Areas 1 & 5	45' Min., 120' Max	
C Lot Coverage		
Areas 1 & 5	60% Max.	

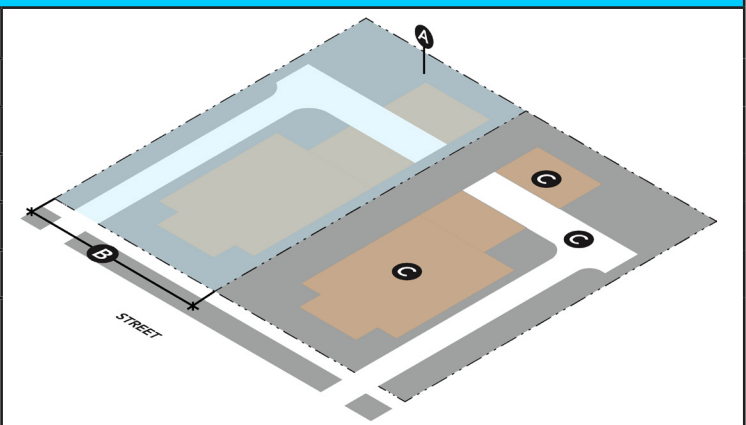

Additional Information

* Where a site will be subdivided into more than one parcel, lot and site design standards should be based on the collective area of all parcels.

SITE*

A Front Setback/Build to Zone (BTZ)		
Areas 1 & 5	10' Min./65% BTZ ¹	
B Side Setback		
Areas 1 & 5	5' Min., Transitional Setback Required ²	
C Rear Setback		
Areas 1 & 5	10' Min, Transitional Setback Required ^{2&3}	
D Building Alignment		
Areas 1 & 5	Required ⁴	
E Garage and Carport Location		
Areas 1 & 5	Parking must be located behind rear wall of primary structure	
F Access and Driveway Width		
Areas 1 & 5	20' Max. ⁵	

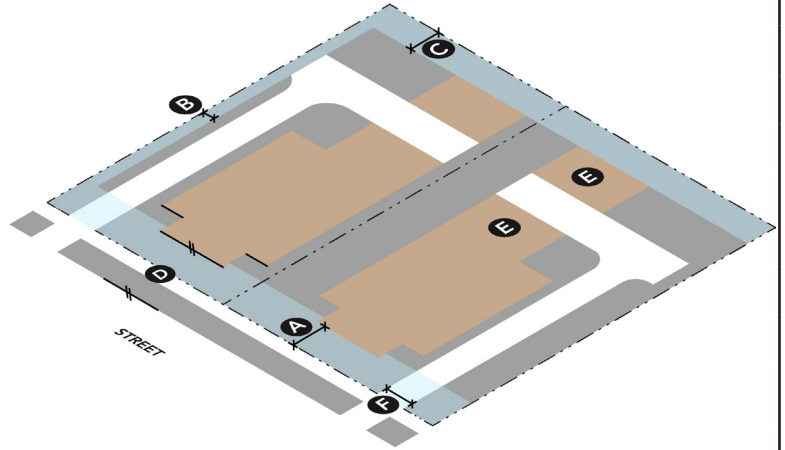

Additional Information

Note: Sidewalks shall be provided along all street frontages in accordance with the Subdivision Regulations.

* Where a site will be subdivided into more than one parcel, lot and site design standards should be based on the collective area of all parcels

- 1 65% of front wall is required to be placed within 10' of required front setback
- 2 For buildings above 1 story, the 2nd story and above must be set back an additional 5' from the shared lot line. This requirement applies on all side and rear lot lines except where otherwise stated or where the property abuts a lot in Area 5, 6 or 7.

- 3 If an alley is present, rear setback is 2' min.
- 4 Building Alignment
Interior Lot: front wall of primary structure shall be parallel to the street
Corner Lot: Both street-facing walls of the primary structure shall be parallel to each street
- 5 Forward of street-facing wall

3-PLEX/4-PLEX/MANSION APARTMENT

BUILDING FORM

A Front Wall Width		
Areas 1 & 5	60' Max. ¹	
B Building Height		
Areas 1 & 5	2 stories/35' Max.	
C Finished Floor Height		
Areas 1 & 5	1' Min., 4' Max	
D Floor Height		
Areas 1 & 5	9' Min., 15' Max	
E Roof Form		
Areas 1 & 5	Pitched or Flat	

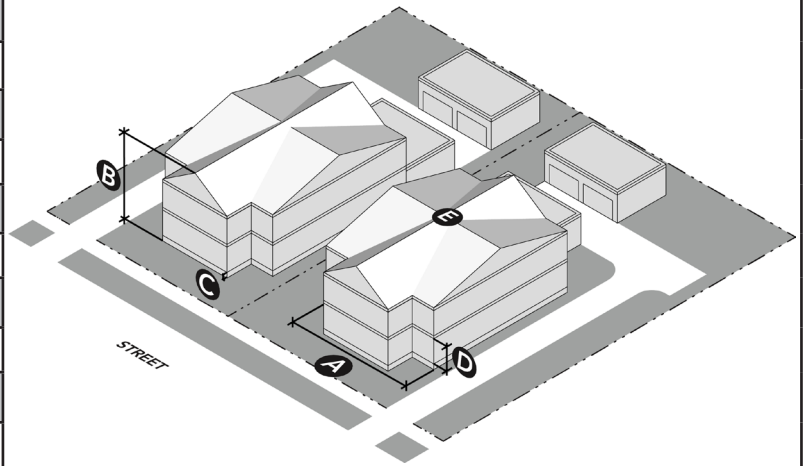

Additional Information

- 1 Only 45' of total front wall width can be located within 25' of the front lot line

BUILDING ACTIVATION

A First Story Element		
Areas 1 & 5	Required ^{1&2}	
B Principal Windows		
Areas 1 & 5	1 Min. on front-most wall ³ 4'x'4 Min. dimensions	
C Blank Street-Facing Wall		
Areas 1 & 5	8' Max.	
D Window Size - Street Facing Wall		
Areas 1 & 5	2'x3', except for an accent windows	
E Entry Location (On Street-Facing Wall)		
Areas 1 & 5	10' Max. distance of entry from front-most wall	
F Entry Number (On Street-Facing Wall)		
Areas 1 & 5	1 Min.	
G Entry Presence - Facing Street		
Areas 1 & 5	Required ⁴	
H Entry Path		
Areas 1	Required ⁵	



Additional Information

- 1 Must include one of the following elements:
 - Projecting Porch
 - Recessed Porch
- 2 Height of first story element must have an interior clearance of at least 8 feet, no greater than 12 feet. Interior clearance is measured from the floor of the first story element to the lowest point of the ceiling of the first story element.
- 3 If height of front wall is greater than 35', 2 principal windows are required
- 4 Visually connect entrance to street through one of the following:
 - Entry faces street
 - Entry opens on porch or stoop that faces street
- 5 Must connect to street through physical, demarcated path

ROWHOUSE

DESCRIPTION

This building form consists of a series of attached units that are narrow and tall, with entries facing the street (on street adjacent walls). This building form has a limit to the width of the total building length so that it relates to neighboring structures and provides a defined front wall for each unit. The Rowhouse form is often raised moderately off the ground and accessed by a porch or stoop to draw attention to the individual entry for each unit. A variety of articulation methods can be used to distinguish each rowhouse unit, including changes in material, wall offsets, and changes in color. Detached garages or a “tuck under garage” (provided within the first floor of each unit) accessed by an alley or internal access drive is typical.



Permitted Areas 1, 5 and 6

LOT*

A Lot Area		
Area 1		9,000 sq.ft.
Area 5		9,000 sq.ft.
Area 6		N/A
B Lot Frontage		
Areas 1 & 5		65' Min.
Area 6		N/A
C Lot Coverage		
Area 1		60% Max.
Area 5		70% Max.
Area 6		N/A

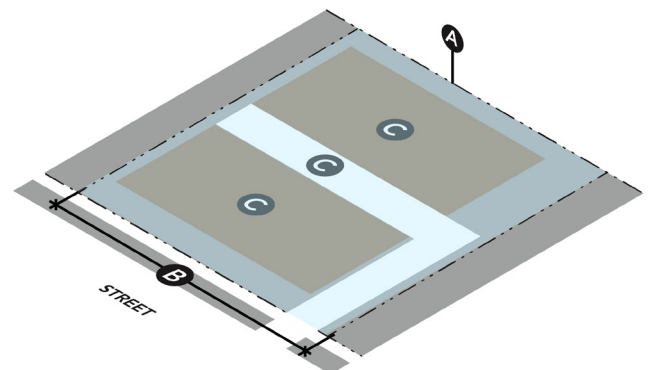

Additional Information

* Where a site will be subdivided into more than one parcel, lot and site design standards should be based on the collective area of all parcels.

SITE*

A Front Setback/Build to Zone (BTZ)		
	Area 1	10' Min./90% BTZ ¹
	Area 5	5' Min./90% BTZ ¹
	Area 6	0' Min; 5' Max. ²
B Side Setback		
	Areas 1, 5 & 6	0' Min., End Unit: 5' Min.; Transitional Setback Required ³
C Rear Setback		
	Areas 1, 5 & 6	10' Min., Transitional setback required ^{3&4}
D Space Between Buildings		
	Areas 1, 5 & 6	10' Min.
E Garage and Carport Location		
	Area 1	15' Min. setback ^{5&6}
	Area 5	20' Min. setback ^{5&6}
	Area 6	30' Min. setback ^{5&6}
F Access and Driveway Width		
	Area 1, 5 & 6	20' Max. ⁷
G Building Alignment		
	Area 1, 5 & 6	Required ⁸

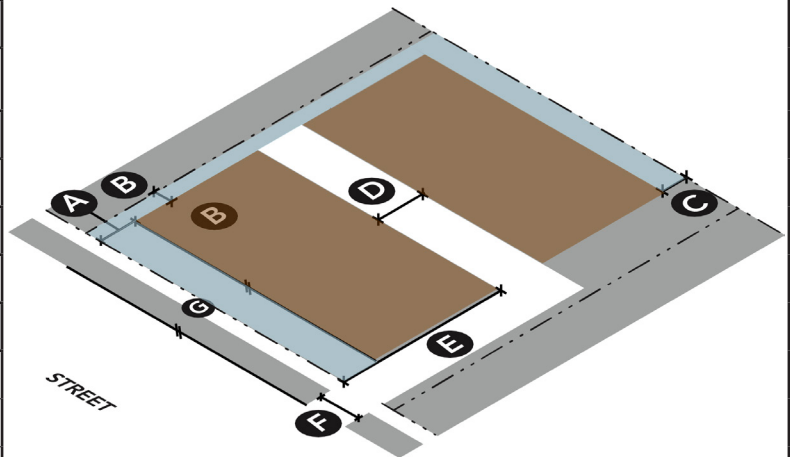

Additional Information

Note: Sidewalks shall be provided along all street frontages in accordance with the Subdivision Regulations.

* Where a site will be subdivided into more than one parcel, lot and site design standards should be based on the collective area of all parcels.

- 1 90% of front wall is required to be placed within 5' of required front setback.
- 2 Exception for permanently hardscaped public plaza, outdoor seating, etc. that is within 5' of the maximum front setback
- 3 For buildings above 1 story, the 2nd story and above must be set back an additional 5' from the shared lot line. This requirement applies on all side and rear lot lines except where otherwise stated or where the property abuts a lot in Area 5, 6 or 7.

- 4 If an alley is present, rear setback is 2' min.
- 5 No parking is allowed between street-facing wall and street
- 6 No garage door can be visible from the street
- 7 If an alley is present, access to a garage, carport or open parking must be from the alley.
- 8 Building Alignment
 - Interior Lot: Front wall of primary structure shall be parallel to street
 - Corner lot: Both street-facing walls of primary structure shall be parallel to each street

ROWHOUSE

BUILDING FORM

A Front Wall Width		
Area 1	100' Max. or 4 units, whichever is less	
Areas 5 & 6	180' Max.	
B Building Height		
Areas 1, 5 & 6	2 stories/25' Min., 3 stories/40' Max. ¹	
C Finished Floor Height		
Areas 1, 5 & 6	1' Min., 4' Max.	
D Roof Form		
Area 1	Pitched or Flat ² If pitched, a slight change in roof pitch must be utilized at least every two units	
Area 5	Pitched, Flat or Sloped	
Area 6	Flat	
E Floor Height		
Areas 1, 5 & 6	9' Min., 15' Max.	

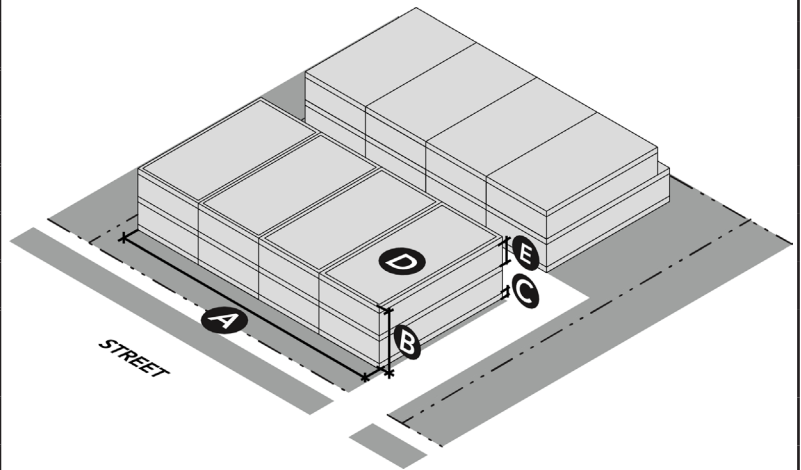

Additional Information

- 1 Max height for a 2-story rowhouse is 35'
- 2 If pitched, a 5°-10° change in pitch or a 2'-5' change in height must be utilized at least every two units.

BUILDING ACTIVATION

A First Story Element		
Areas 1, 5 & 6	Required ^{1&2}	
B Principal Windows		
Areas 1, 5 & 6	1 Min. on front-most wall; 4'x4' Min.	
C Blank Street-Facing Wall		
Areas 1, 5 & 6	8' Max.	
D Window Size - Street-Facing Wall		
Areas 1, 5 & 6	2'x3', except for an accent windows ³	
E Entries Per Unit		
Areas 1, 5 & 6	1 Min.	
F Distance Between Entries		
Areas 1, 5 & 6	30' Max.	
G Entry Location (On Street-Facing Wall)		
Areas 1, 5 & 6	5' Max. from front-most wall	
H Entry Presence - Facing Street		
Areas 1, 5 & 6	Required ⁴	
I Entry Path		
Areas 1, 5 & 6	Required ⁵	

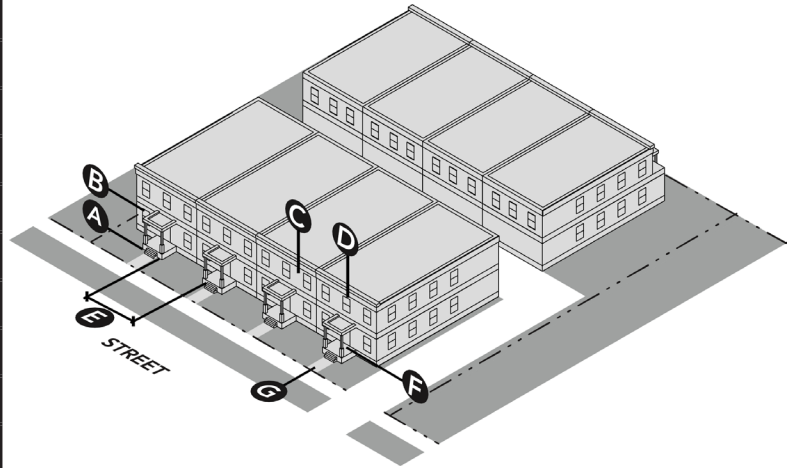

Additional Information

- 1 Must include one of the following elements on the front-most façade of each unit:
 - Projecting Porch
 - Recessed Porch
 - Projecting Stoop
- 2 Height of first story element must have an interior clearance of at least 8 feet, no greater than 12 feet. Interior clearance is measured from the floor of the first story element to the lowest point of the ceiling of the first story element.
- 3 If height of front wall is greater than 35', 2 principal windows are required.
- 4 Visually connect entrance to street through one of the following:
 - Entry faces street
 - Entry opens on porch or stoop that faces street
- 5 Must connect to street through physical, demarcated path

FLATS

DESCRIPTION

A Flat is a multi-story, residential building form that increases density in targeted single-family areas and provides an additional housing option in commercial and mixed-use areas. A flat includes floors of “stacked” residential units. Common entries and circulation corridors typically provide access to individual units. Flats may be single-loaded with a circulation hallway on one side of the building or double-loaded with units on both side of a building with a common hallway through the middle. The location and connection of an entry to the street and the articulation of the building walls provide architectural interest and create a more pedestrian-friendly environment.

Permitted in Areas: 1, 5, 6 & 7



LOT

A Lot Area		
Areas 1 & 5	9,000 sq. ft. Min.	
Areas 6 & 7	N/A	
B Lot Frontage		
Areas 1 & 5	65' Min.	
Areas 6 & 7	N/A	
C Lot Coverage		
Area 1	60% Min.	
Area 5	70% Min.	
Areas 6 & 7	N/A	

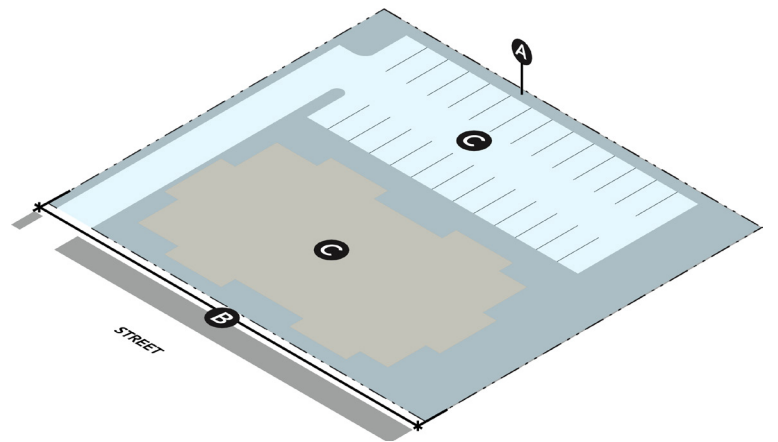

SITE

A Front Setback/Build to Zone (BTZ)		
Area 1		10' Min./65% in BTZ ¹
Area 5		5' Min./75% in BTZ ²
Area 6		0' Min., 5' Max. ³
Area 7		10' Min., 75' Max.
B Side Setback		
Areas 1 & 5		5' Min., Transitional Setback Required ⁴
Area 6		0' Min., 5' Max. on Exterior Side
Area 7		15' Min.
C Rear Setback		
Areas 1, 5, 6 & 7		10' Min., Transitional Setback Required ⁴
D Space Between Buildings		
Areas 1 & 5		10' Min
Area 6		N/A ³
Area 7		15' Min.
E Building Alignment		
Area 1, 5, 6 & 7		Required ⁶
F Access and Driveway Width		
Area 1, 5, 6 & 7		26' Min., 30' Max.
G Parking Location		
Area 1		15' Min. ⁷
Area 5		20' Min. ⁷
Area 6		25' Min. ⁷
Area 7		None ⁸

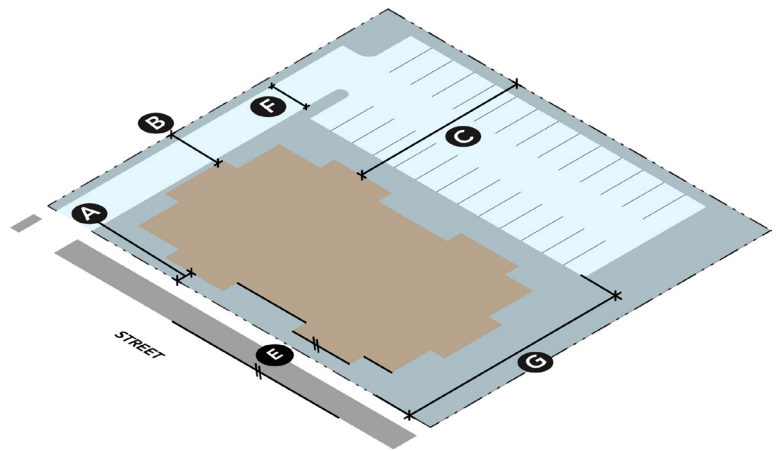

Additional Information

Note: Sidewalks shall be provided along all street frontages in accordance with the Subdivision Regulations.

- 65% of front wall is required to be placed within 10' of required front setback
- 75% of front wall is required to be placed within 5' of required front setback
- Maximum building setback may be increased up to 30' if a plaza, outdoor seating or other publicly-accessible amenity is provided within the setback.

- For buildings above 1 story, the 2nd story and above must be set back an additional 5' from the shared lot line. This requirement applies on all side and rear lot lines except where otherwise stated or where the property abuts a lot in Area 5, 6 or 7.
- If there are less than 10' between buildings, there are building code requirements that must be met.
- Entry, corner and other accent elements do not have to be parallel to the street as the primary structure is required to be.
- No parking is permitted between street-facing wall and street
- Maximum of one double-row of parking is allowed between street-facing wall and street

FLATS

BUILDING FORM

A Wall Length		
Area 1	100' Max.	
Area 5	140' Max.	
Area 6	180' Max.	
Area 7	240' Max.	
B Building Height		
Area 1	2 stories/25' Min.; 3 stories/35' Max.	
Area 5	2 stories/25' Min.; 4 stories/45' Max.	
Area 6	2 stories/25' Min.; 5 stories/60' Max.	
Area 7	2 stories/25' Min.; 6 stories/70' Max.	
C Finished Floor Height		
Areas 1, 5, 6 & 7	1' Min., 4' Max.	
D Floor Height		
Areas 1, 5, 6 & 7	9' Min., 15' Max	
E Roof Form		
Area 1	Pitched or Flat	
Area 5	Pitched, Flat or Sloped	
Area 6	Flat	
Area 7	Pitched, Flat or Sloped	
F Garage and Carport (if visible)		
Areas 1, 5 & 6	Not allowed to be visible from street	
Area 7	If visible from street, 9' Max. Height	

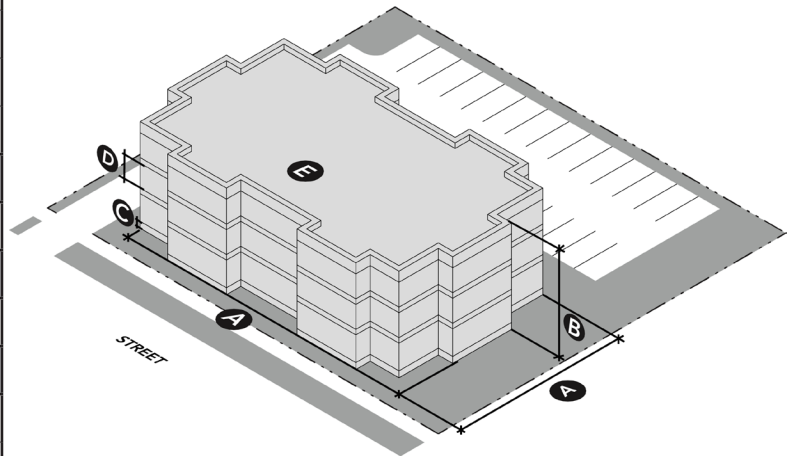

BUILDING ACTIVATION

A Entry Number (On Street-Facing Wall)		
Areas 1, 5, 6 & 7	1 Min.	
B Distance Between Entries		
Area 1	40' Max.	
Area 5	50' Max.	
Areas 6 & 7	60' Max.	
C Entry Presence - Facing Street		
Areas 1, 5, 6 & 7	Required	
D Entry Path		
Areas 1 & 5	Required	
Area 6	Required, if building is setback	
Area 7	Required ¹	
E Blank Street-Facing Wall		
Areas 1, 5, 6 & 7	8' Max.	
F Window Size - Street-Facing Wall		
Areas 1, 5, 6 & 7	2'x3' Min.	
G Building Articulation Options		
Areas 1 & 5	1 articulation option (AO) required; 2 AOs required if wall is over 40' wide ²	
Area 6	1 AO required; 3 AOs required if wall is over 60' wide ²	
Area 7	1 AO required; 3 AOs required if wall is over 80' wide ²	

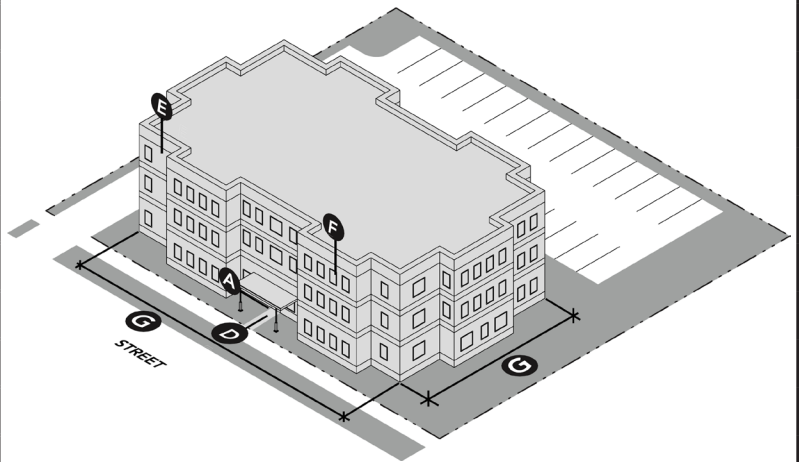

Additional Information

1. To private walk, sidewalk, etc. if it is separated by landscaping or other similar surface

2. Building Articulation Options (AOs) for street-facing facade:

- Height variation
- Increase setbacks
- Stepbacks
- Accent lines
- Color changes
- Material change
- Wall offsets

MIXED-USE A

DESCRIPTION

This building form facilitates office and residential uses within one structure mixed vertically and/or horizontally, with limited supporting retail. Its scale and intensity is limited to facilitate a neighborhood-compatible mixed-use building that transitions appropriately to areas of strictly residential character. For instance, these may take the form of a small corner shop with rowhouses or flats continuing down the block. The ground-floor requires transparency minimums for certain retail uses as well as limits on the linear percentage of active storefronts. Mixed-Use A also accommodates offices and residential uses. This very flexible building form may include components of many other building forms described in this Chapter. Parking for residents and office and retail employees in this building form is typically aggregated in adjacent surface parking lots or structured garages. However, buildings that are predominantly residential may also incorporate individual garages within the design of the primary structure. This building form also commonly requires nearby, on-street parking for short-term office visitors and retail patrons.

Permitted in Area 5



LOT

A Lot Area		
Area 5	9,000 sq. ft. Min.	
B Lot Frontage		
Area 5	65' Min.	
C Lot Coverage		
Area 5	70% Max.	

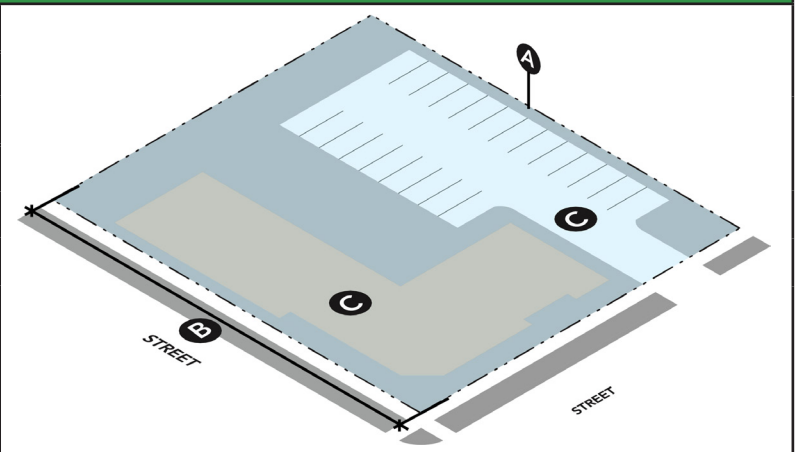

SITE

A Front Setback/Build to Zone (BTZ)		
Area 5		5' Min./75% BTZ ¹
B Side Setback		
Area 5		5' Min. ²
C Rear Setback		
Area 5		10' Minimum ^{2&3}
D Building Alignment		
Area 5		Required ^{4&5}
E Access and Driveway Width		
Area 5		20' Max. forward of street-facing wall
F Parking Location		
Area 5		30' Min. setback from front property line, 10' Min. setback from residential ⁶

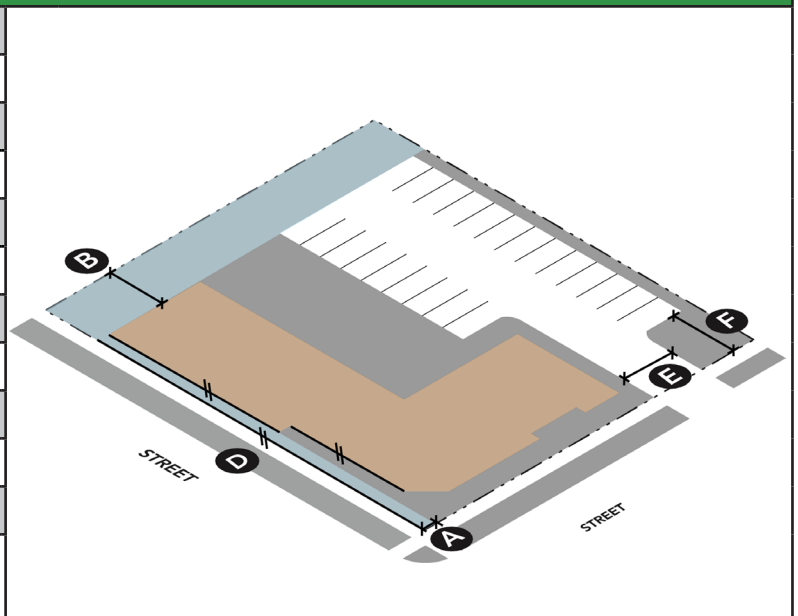

Additional Information

Note: Sidewalks shall be provided along all street frontages in accordance with the Subdivision Regulations.

- 1 75% of front wall is required to be placed within 10' of required front setback
- 2 For buildings above 1 story, the 2nd story and above must be set back an additional 5' from the shared lot line. This requirement applies on all side and rear lot lines except where otherwise stated or where the property abuts a lot in Area 5, 6 or 7.

3 If an alley is present, rear setback is 2' min.

4 Building Alignment

Interior Lot: Front wall of primary structure shall be parallel to street

Corner lot: Both street-facing walls of primary structure shall be parallel to each street

5 Exception for corner accent or entry features

6 No parking between street-facing wall and street

MIXED-USE A

BUILDING FORM

A Wall Length		
Area 5	160' Max.	
B Building Height		
Area 5	2 stories/25' Min., 4 stories/50' Max.	
C Finished Floor Height		
Area 5	1' Min, 4' Max. ¹	
D Roof Form		
Area 5	Pitched, Flat or Sloped	
E Floor Height		
Area 5	For mixed-use components, see floor height rules for Mixed-Use B; For residential component, see floor height rules for Rowhouse for Flats	

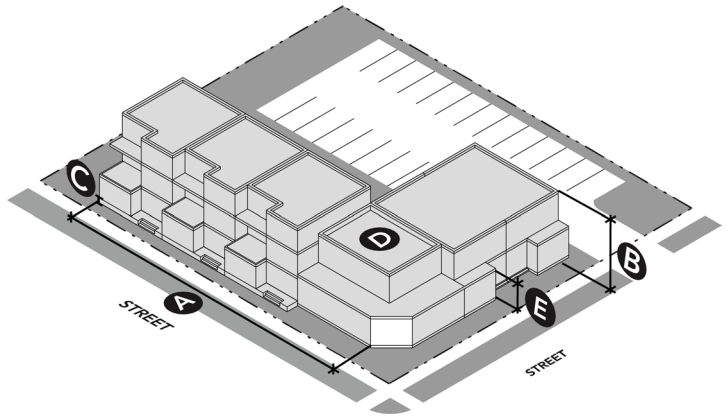

Additional Information

- 1 No raised foundation is required for a commercial ground floor

BUILDING ACTIVATION

A First Story Element		
Area 5	Required ¹ & ²	
B Entry Number (On Street-Facing Wall)		
Area 5	1, Minimum	
C Distance Between Entries		
Area 5	30' Max. ³	
D Entry Presence - Facing Street		
Area 5	Required ⁴	
E Entry Path		
Area 5	Required ⁵	
F Blank Street-Facing Wall		
Area 5	10' Max.	
G Window Size - Street-Facing Wall		
Area 5	2'x3' Min., except for accent windows	
H Ground-Floor Transparency		
Area 5	55% Min.	
I Active Retail Storefront		
Area 5	25% Max. of total linear street frontage	
J Parking Screening		
Area 5	Required, if visible from street ⁶	

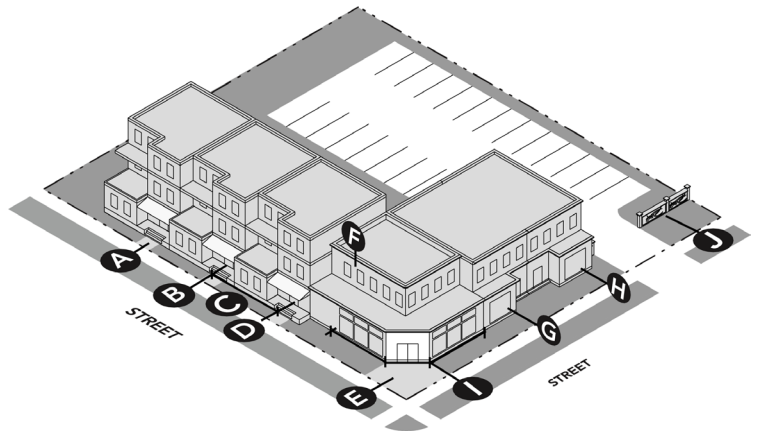

Additional Information

- 1 If a Rowhouse component is used as part of the mixed-use building form, must include one of the following elements on the front-most façade of each unit:
 - Projecting Porch
 - Recessed Porch
 - Projecting Stoop
- 2 Height of first story element must have an interior clearance of at least 8 feet, no greater than 12 feet. Interior clearance is measured from the floor of the first story element to the lowest point of the ceiling of the first story element.

- 3 Refer to specific building form standards
- 4 Visually connect entrance to street through one of the following:
 - Entry faces street
 - Entry opens on porch that faces street
- 5 Must connect to street through physical, demarcated path
- 6 Parking screening options include: Site Wall, Landscaping, Fence

MIXED-USE B/COMMERCIAL

DESCRIPTION

This form facilitates the mixing of commercial, office and potentially residential uses within one structure. Mixed-Use B/Commercial also accommodates commercial or office uses as sole uses within a single building. It is characterized by generous ground floor heights, active ground floor uses (such as shops or offices). In many cases, office or residential components are included on upper floors with the ground floor dedicated to retail uses. Entries are typically clearly demarcated for individual components of a building, like common residential entries or storefronts. Ground floors are highly articulated and exhibit high percentages of transparency. Internal circulation is critical to connecting uses within the building and elevators are widely used where multiple stories exist. Parking for residents and office and retail employees in this building form is typically aggregated in adjacent surface parking lots or structured garages. This building form exhibits a high number of visitors and shopping patrons, which makes high-turnover, on-street parking critical.



Permitted in Areas 6 & 7

LOT

No lot standards are provided for Mixed-Use B/Commercial. It is assumed that buildings in this form will utilize the full lot.

SITE

A Front Setback/Build to Zone (BTZ)		
Area 6	0' Min., 5' Max. ¹ Upper Floor Street Setback Required ²	
Area 7	10' Min, 75' Max. ¹	
B Side Setback		
Area 6	0' Min, 5' Max. exterior side setback	
Area 7	10' Min. ³	
C Rear Setback		
Areas 6 & 7	10' Min. ^{3&4}	
D Building Alignment		
Areas 6 & 7	Required ^{5&6}	
E Space Between Buildings		
Areas 6 & 7	0' Min, 10' Max.	
F Parking Location		
Area 6	30' Min. setback from front property line, 10' Min. setback from residential ⁷	
Area 7	1 double row Max. between street-facing wall and street 10' Min. setback from front property line, 10' Min. setback from residential	
G Parking Access		
Area 6	Max. 1 access point per block from Main Street and Broadway Avenue ⁸	
Area 7	Limit access from perimeter corridors ⁹	
H Access and Driveway Width		
Area 6	20' Max.	
Area 7	24' Max	

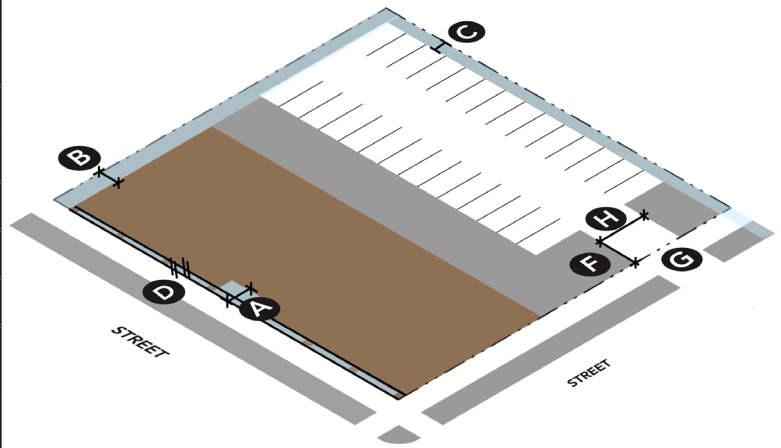

Additional Information

Note: Sidewalks shall be provided along all street frontages in accordance with the Subdivision Regulations.

- 1 Maximum building setback may be increased up to 30' if a plaza, outdoor seating or other publicly-accessible amenity is provided within the setback.
- 2 For buildings above 3 stories, the 4th story and above must be set back 15' from the property line
- 3 For buildings above 1 story, the 2nd story and above must be set back an additional 5' from the shared lot line. This requirement applies on all side and rear lot lines except where otherwise stated or where the property abuts a lot in Area 5, 6 or 7.

4 If an alley is present, rear setback is 2' min.

5 Building Alignment

Interior Lot: Front wall of primary structure shall be parallel to street

Corner lot: Both street-facing walls of primary structure shall be parallel to each street

6 Exception for corner accent or entry features

7 No parking forward of street-facing wall

8 Must access parking from alley or side street

9 Where feasible, access parking from side street

MIXED-USE B/COMMERCIAL

BUILDING FORM

A Front Wall Width		
Area 6	300' Max.	
Area 7	160' Max.	
B Building Height		
Area 6	2 stories/25' Min, 6 stories/70' Max.	
Area 7	6 stories/70' Max.	
C Floor Height (Ground Floor)		
Area 6	14' Min.	
Area 7	12' Min.	
D Floor Height (Non-Ground Floor)		
Area 6 & 7	9' Min., 15' Max	
E Roof Form		
Area 6	Flat	
Area 7	Pitched, Flat or Sloped	

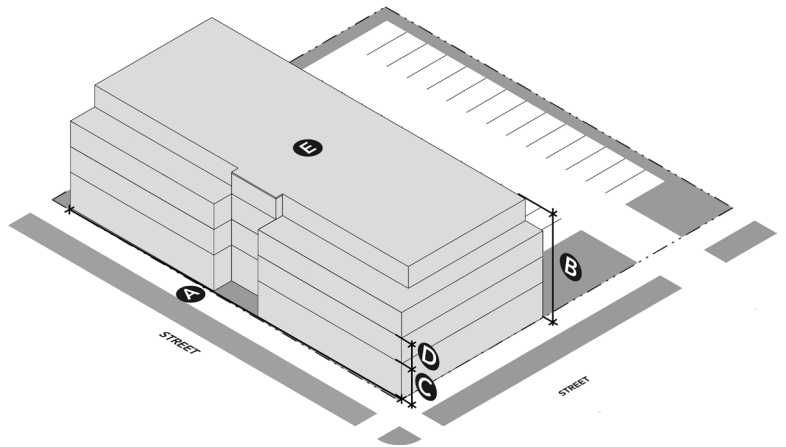

BUILDING ACTIVATION

A Blank Street-Facing Wall		
	Area 6	8' Max.
	Area 7	12' Max.
B Window Size - Street-Facing Wall		
	Areas 6 & 7	2'x3' Min., except for accent windows
C Ground-Floor Transparency		
	Area 6	70% Min.
	Area 7	60% Min.
D Entry Number (On Street-Facing Wall)		
	Areas 6 & 7	1 Min.
E Distance Between Entries		
	Area 6	30' Max.
	Area 7	45' Max.
F Entry Presence - Facing Street		
	Areas 6 & 7	Required on at least one street.
G Building Articulation Options		
	Area 6	1 AO required; 3 AOs required if wall is over 60' wide ¹
	Area 7	1 AO required; 3 AOs required if wall is over 80' wide ¹
H Parking Screening		
	Areas 6 & 7	Required if visible from the street ²

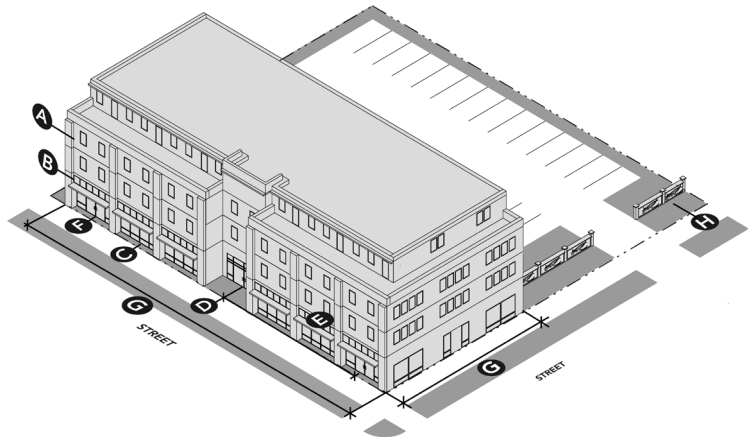

Additional Information

1 Articulation Options (AOs) for street-facing facade:

- Height variation
- Increase setbacks
- Stepbacks
- Accent lines
- Color changes
- Material change
- Wall offsets

* Refer to Chapter 6 for more information about the articulation options

2 Parking screening options include:

- Site wall
- Landscaping
- Fencing

VI. REFERENCE SHEETS

THE FOLLOWING TABLES ARE INCLUDED IN THIS CHAPTER:

TABLES 2 AND 3: BUILDING MATERIALS STANDARDS TABLES

Table 2 indicates which building materials are permitted in each Area. Table 3 provides illustrations for each of the permitted building materials.

TABLE 4: ROOF TYPES TABLE

Table 4 indicates which roof types are permitted in each Area.

TABLE 5: DEFINITIONS TABLE

Table 5 provides a list of key terms that are used in the document. In addition to a definition for each term, illustrations are provided to highlight the term. Definitions of each building articulation method are also provided.

Table 2: Building Material Standards

✓	= Permitted	Area 1 Residential 1	Area 2 Residential 2	Area 3 Residential 3	Area 4 Residential 4	Area 5 Rose District Transition	Area 6 Commercial/ Mixed-use Core	Area 7 Commercial/ Mixed-use Corridor
1. Stucco								
a. Authentic		✓	✓		✓	✓	✓	✓
b. Synthetic		✓	✓			✓		✓
2. Masonry								
a. Brick		✓	✓	✓	✓	✓	✓	✓
b. Stone		✓	✓		✓	✓	✓	✓
c. Patterned Pre-cast Concrete						✓	✓	✓
d. Cement Board Siding						✓	✓	✓
e. Terra Cotta & Ceramic Block						✓	✓	✓
f. Detailed Concrete						✓	✓	✓
g. Concrete Masonry Unit						✓	✓	✓
h. Prefabricated Brick Panels						✓	✓	✓
3. Siding								
a. Wood Shingle		✓	✓	✓	✓			
b. Cementitious Shingle		✓	✓		✓			
c. Wood Clapboard		✓	✓	✓	✓			
d. Cementitious Clapboard		✓			✓	✓	✓	✓
4. Metal								
a. Metal Panels						✓	✓	✓
b. Architectural Metal						✓	✓	✓
5. Glass								
a. Architectural Glass						✓	✓	✓

Table 3: Building Material Standard Illustrations

1. Stucco

a. Authentic



b. Synthetic (scored)



c. Synthetic (not scored)

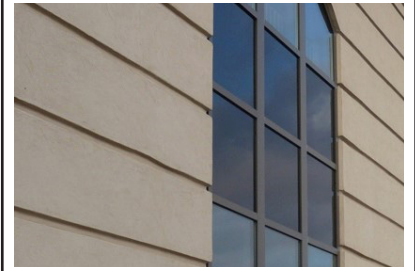

2. Masonry

a. Brick

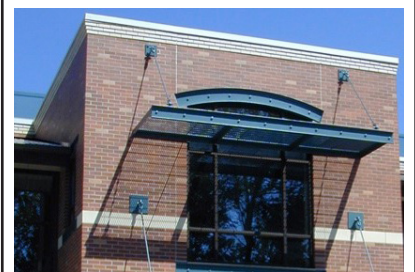
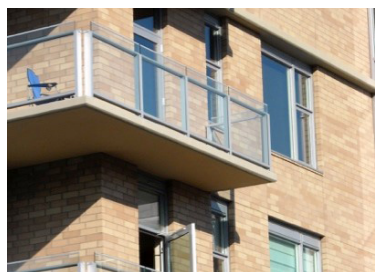



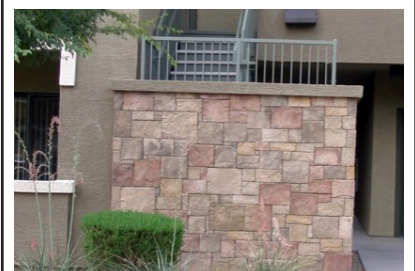
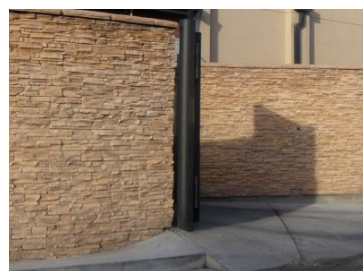
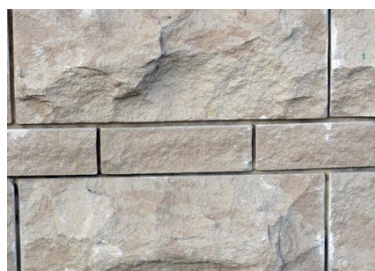



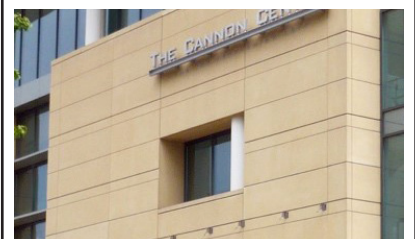
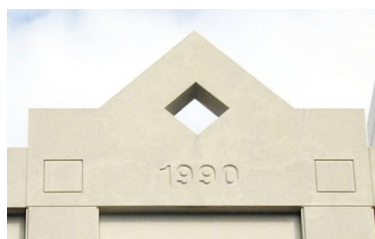

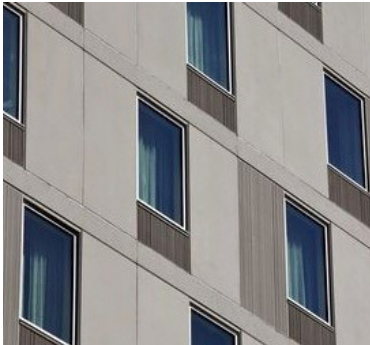
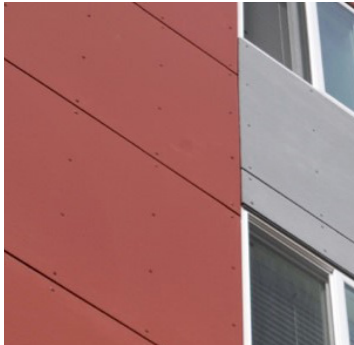



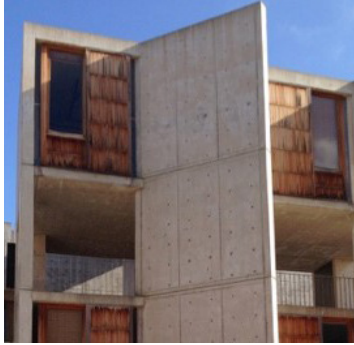

b. Stone











c. Patterned Pre-cast Concrete



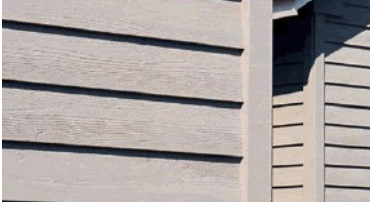



<p>d. Cement Board Siding</p>			
<p>e. Terra Cotta & Ceramic Block</p>			
<p>f. Detailed Concrete</p>			
<p>g. Concrete Masonry Unit</p>			
<p>h. Prefabricated Brick Panels</p>			

3. Siding

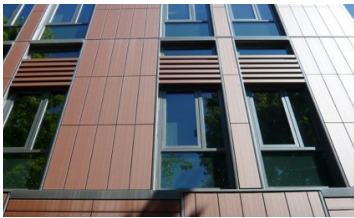
a. Wood Shingle			
b. Cementitious Shingle			
c. Wood Clapboard			
d. Cementitious Clapboard			

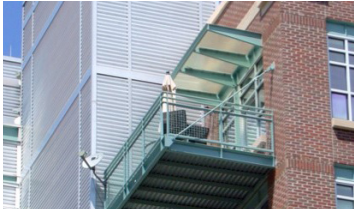
4. Metal

a. Metal Panel			
b. Architectural Metal.4			

5. Glass

a. Architectural Glass			
------------------------	---	--	---

Table 4: Roof Types

1. Flat Roof



2. Pitched (Gable)



3. Pitched (Hipped)



4. Sloped (Butterfly)



5. Sloped (Shed)

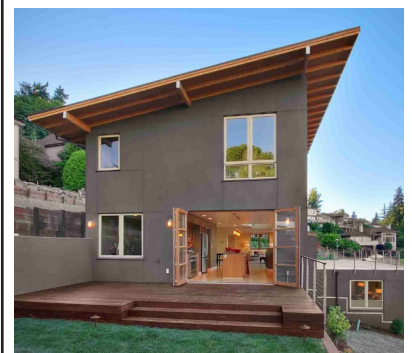

Table 5: Definitions

General Definitions

Accent Element

A building component that provides visual interest and/or texture to an overall building form. An accent element may include a window, wall offset or variation in material.



Alley

A secondary vehicular way or thoroughfare that provides rear access to properties on both sides of a block. An alley is narrower than a street, and can be paved or unpaved.

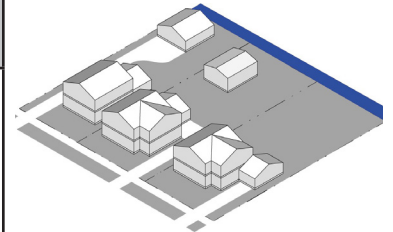

Corner Lot

A parcel that is bordered by streets on two sides. A corner lot only has an adjacent property on one side, and may have an alley or another property to the rear.

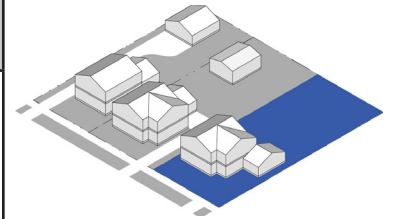

Entry Door

An entry door that faces the street is a door that is parallel to and oriented to the street. This could include a door that opens onto a porch or stoop, as long as the door orients to the street. An entry that opens onto a porch that faces the street, on the other hand, is placed perpendicular to the street. This means that from some angles from the public realm, the entry door will not be visible.

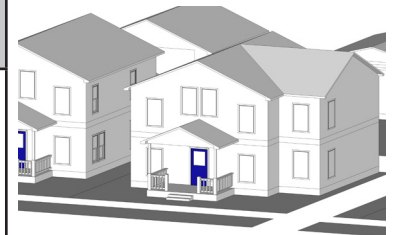

Front Wall

The street-facing (or common courtyard in the case of the Cottage Court building form) exterior wall of a building. The front wall may consist of multiple wall planes that compose entire front face of the building. The primary entry to a building is on the front wall.

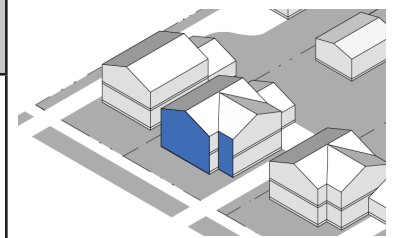

Front-Most Wall

The front-most wall of a building that is closest in distance to the street (or the common courtyard in the Cottage Court building form).

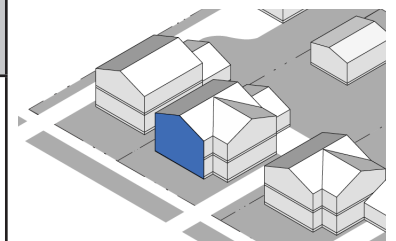

Finished Ground Floor Height

The ground floor level is the distance from grade to the floor of the first story of a building.

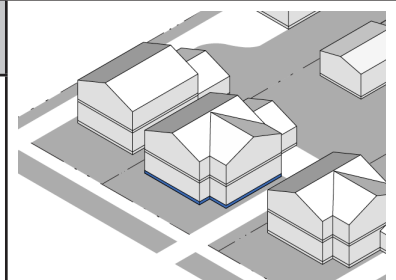

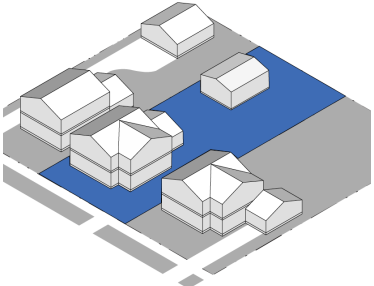
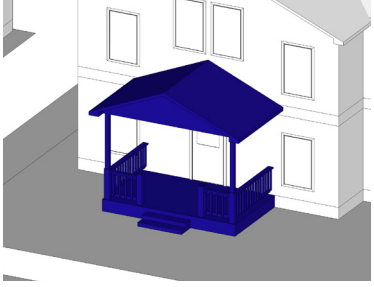
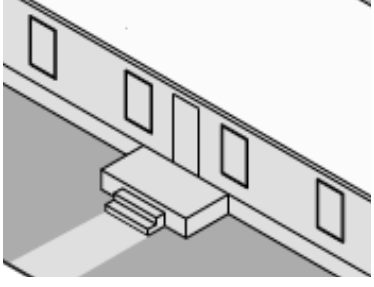
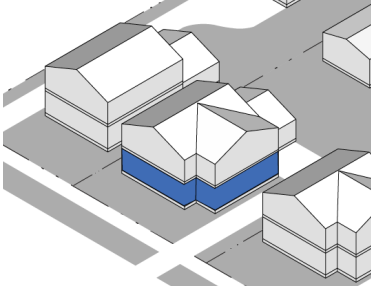
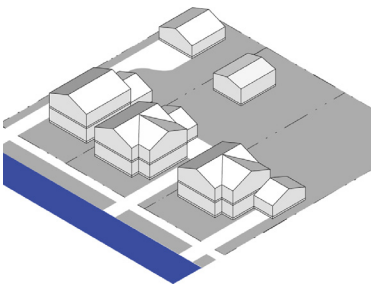
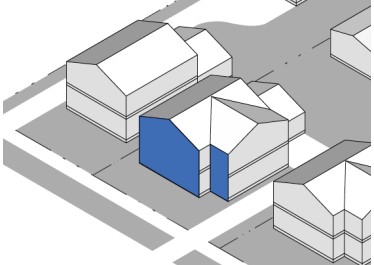
<p>Interior Lot</p>	
<p>A parcel with street-access on one side and an alley or separate parcel on the opposite. An additional parcel sits on each side of an interior lot.</p>	
<p>Porch</p>	
<p>A raised, roofed platform attached to the front wall of a building. The primary entry to a building opens onto the porch. A porch can project from the front-façade or be recessed into the building form. A porch must be open on at least one (1) side, must be roofed and must not be taller than the height of the first story of a building. The roof of the porch is permitted to extend above the first story of the building. The minimum dimensions for a porch are 10' wide x 6' deep.</p>	
<p>Stoop</p>	
<p>A stoop is a small, raised platform that serves as an entryway to a building. A stoop is open on three sides and is raised off the ground. It is defined primarily by its lack of roof with structural support and instead may be covered by a canopy or awning that projects from the primary structure. The minimum dimensions of a stoop are 4' wide by 4' deep. A stoop must not be more than 10' deep, and must not be taller than the height of the first story of the building (if a roof is utilized).</p>	
<p>Floor Height</p>	
<p>The floor height is measured from the base of the floor to the ceiling of the story.</p>	
<p>Street</p>	
<p>A primary vehicular way or thoroughfare that provides access to the front of each property on a block. On corner lots, a property can also be accessed by a second street that runs parallel to the side wall of the building.</p>	
<p>Street-Facing Wall</p>	
<p>Any side of a building that faces the street (or the common courtyard in the cottage court building form). A street-facing façade/street-facing wall may refer to multiple wall planes on a building that face the street.</p>	

Window Definitions

Principal Window

A large window on a front wall of a building. Minimum dimensions for a principal window are provided for each building form. A principal window can be comprised of multiple operable windows placed together with little space between the casing of each window, each at least 1'x1' in dimension.

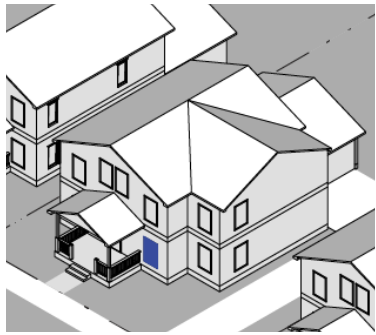

Accent Window

A small, decorative, non-operable window that adds visual interest to a wall of a building. This includes stained glass windows, arched windows and oval windows.



First Story Element Definitions

Projecting Porch

A projecting porch extends from the front wall of the building and adds semi-private space to the exterior of a building. A projecting porch must be covered and must abide by the minimum porch dimensions as described in "General Definitions".

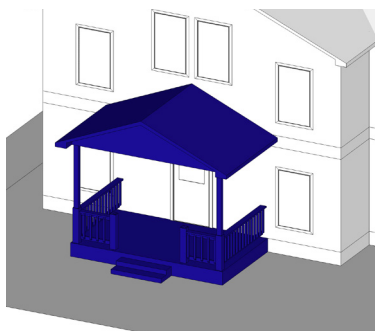

Recessed Porch

A recessed porch recedes into the front wall of a building. A recessed porch has a second story or roof of the building above the porch area, and must abide by the minimum porch dimensions as described in "General Definitions".

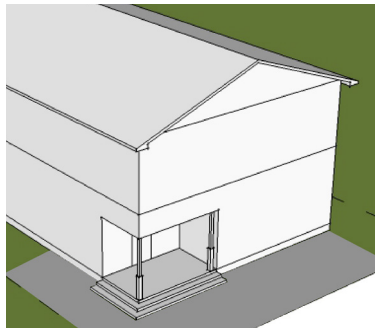

Projecting Stoop

A projecting stoop extends from front-façade of a building, beginning at the primary entry and ending with a step or step(s) onto a path leading to the street. A projecting stoop must abide by the dimensions for a stoop as described in "General Definitions", and may be covered or uncovered and have a railing or no railing.

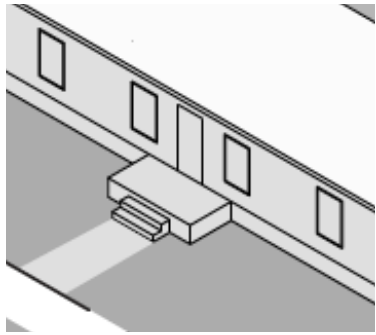

Building Articulation Options

1. Height Variation

A height variation is an actual reduction in the vertical scale of a building of at least one floor. (Note that it is not the intent of this variation method to require multiple elevators.)

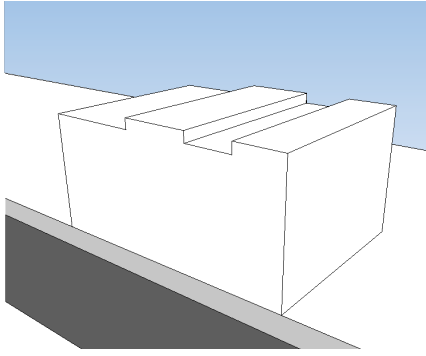

2. Increased Setbacks

An increased setback is similar to a minor wall offset, but with a larger dimension. It is established by providing a larger setback on a portion of a wall for its full height.

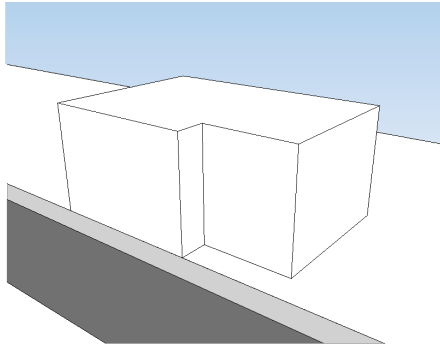

3. Accent Lines

Accent lines include vertical and horizontal expression lines on a building wall. An accent line often projects slightly from the face of a building wall.

Examples include:

- Moldings
- Sills
- Cornices
- Canopies
- Spandrels

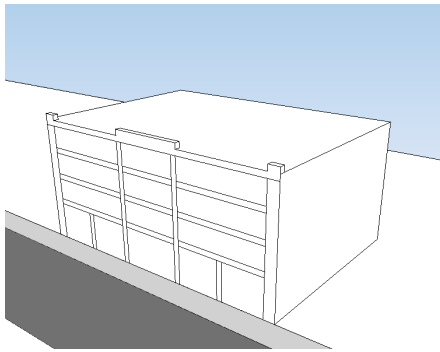

4. Color Changes

Color changes include significant vertical or horizontal changes (15'-30' min.) in color on a building wall.

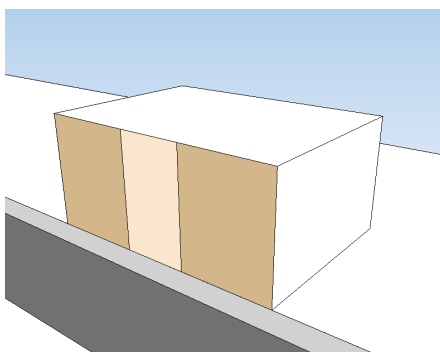

5. Material Change

Material changes include significant vertical or horizontal changes (15'-30' min) in material on a building wall.

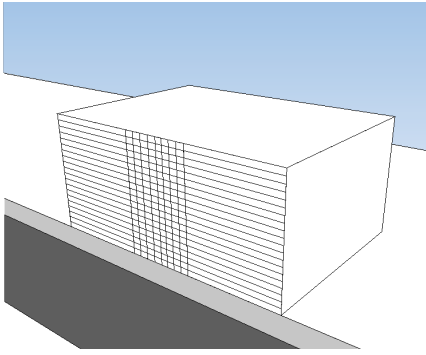

6. Wall Offsets

A wall offset is a vertical expression line created by notching a building wall for its full height. Wall offsets are at least 2'.

